

SCYLAR INT 8
Calculator

Installation and User Guide



Contents

1	General	4
1.1	About this Installation and User Guide	4
1.1.1	Target groups	4
1.1.2	Subject to change, validity	4
1.1.3	Completeness	4
1.1.4	Storage location	4
1.1.5	Warning signs	4
1.1.6	Symbols	5
1.2	Marking	5
1.2.1	CE marking	5
1.2.2	EC declaration of conformity	5
1.3	Copyright	5
2	Safety	6
2.1	Intended use	6
2.1.1	Misuse	6
2.2	Basic safety instructions	6
2.2.1	Product safety	6
2.2.2	Obligations of operator	6
2.2.3	Obligations of trained personnel/user	7
2.3	Specific hazards	7
3	Product description	8
3.1	Mechanical design	8
3.2	Scope of delivery	8
3.3	Labelling	9
3.4	Functional description	9
3.5	Power supply	10
3.5.1	Battery	11
3.5.2	Overview of the measuring rates	11
3.5.3	Mains unit	12
3.6	Calculator interfaces	12
3.6.1	Communication modules	13
3.6.2	Function modules	14
4	Technical data	16
4.1	Dimensions	16
4.2	General data	17
4.3	Power supply	17
4.4	Calculator interfaces	17
4.4.1	Communication modules	17
4.4.2	Function modules	19
4.4.3	Test output	23

5	Transport, storage.....	24
5.1	Unpacking the calculator.....	24
5.2	Transporting the calculator	24
5.3	Storage of calculator	24
6	Installation	25
6.1	Installation	26
6.1.1	Installing the calculator	27
6.1.2	Connecting temperature sensor.....	31
6.1.3	Installing the temperature sensor.....	33
6.2	Installing extension modules.....	35
6.2.1	Display of the slot configuration	38
6.3	Connecting modules	39
6.3.1	Connecting communication modules	39
6.3.2	Connecting function modules.....	40
6.4	Connecting the mains voltage 230 V / 24 V	41
6.5	Programming the calculator	42
7	Taking into operation.....	43
8	Operation	44
8.1	Display	44
8.2	Operation of calculator	44
8.3	Display indications (default settings).....	45
9	Maintenance and repair	56
10	Testing.....	57
11	Removal	58
12	Error analysis	59
13	Declaration of conformity.....	60

1 General

1.1 About this Installation and User Guide

This Installation and User Guide refers exclusively to the SCYLAR INT 8 calculator and is part of the product. It describes how to use this product safely for the intended purpose throughout the product life cycle.

1.1.1 Target groups

Operators

The operator must ensure that personnel using the calculator read and observe the instructions given in this guide and all necessary associated documents, particularly the safety instructions and warning signs.

Trained personnel/users

Trained personnel must read, observe and follow the instructions given in this guide and the necessary associated documents, particularly the safety instructions and warning signs.

1.1.2 Subject to change, validity

The information contained in this Installation and User Guide is valid at the time of release of this version. The version number and release date of this Installation and User Guide are shown on the back of the document. Changes to this guide are possible at any time.

1.1.3 Completeness

This Installation and User Guide is only complete in conjunction with the relevant associated documents for the respective application.

1.1.4 Storage location

This Installation and User Guide and all relevant associated documents for the respective application must be readily available and accessible at all times in the vicinity of the calculator or the overriding system.





1.1.5 Warning signs

The warning levels indicated by the warning signs are explained below.

Signal word	Level of danger	Consequences of non-compliance
DANGER	Direct threat of danger	Death or serious injury
WARNING	Possible threat of danger	Death or serious injury
CAUTION	Possible dangerous situation	Slight injuries

1.1.6 Symbols

The symbols used in this Installation and User Guide are explained below.

Symbol	Meaning
	This symbol is the safety sign. All measures marked with the safety sign must be observed. It is used on warning signs.
	This symbol is a safety sign indicating that the ESD (electrostatic discharge) regulations must be observed. It is used on warning signs.
	This symbol draws attention to information.
	This symbol indicates a requirement that must be fulfilled before taking action.
1. , 2. , ...	These numbers indicate the steps in a sequence of numbered actions.
	This symbol shows the instructions for avoiding danger in a warning instruction or an individual step.

1.2 Marking

1.2.1 CE marking

This product bears the CE marking, the metrology marking and the identification number of the notified body. See Section 3.

1.2.2 EC declaration of conformity

The calculator complies with the directives and standards for MID-approved meters as stated in the EC declaration of conformity. The EC declaration of conformity contains the number of the EC type examination certificate. A copy of the EC declaration of conformity can be found at the end of this document.

1.3 Copyright

© 2012 Hydrometer GmbH

All rights reserved.

No part of this Installation and User Guide may be reproduced in any form whatsoever (printing, photocopying or other process) or processed, reproduced or distributed by means of electronic systems without our written consent. Claims for damages will be asserted in the event of contravention.

Subject to change.

2 Safety



NOTE

Observe the following requirements before carrying out work of any kind.

2.1 Intended use

The calculator is used for recording all billing data for local and district heating and cooling.

2.1.1 Misuse

Operation of the calculator outside the specified operating and environmental conditions is not permitted.

2.2 Basic safety instructions

2.2.1 Product safety

The calculator is produced to the latest state of the art and the recognized safety standards, but the possibility of danger to the user, adverse effects on the calculator itself or on other property cannot be ruled out.

- Use the calculator only for the intended purpose in a fault-free condition with due regard for safety and hazards and in compliance with this guide.
- Keep this guide and all associated documents in a complete and legible state and accessible to personnel at all times.
- Avoid any kind of work that endangers personnel, persons not involved or third parties.
- In addition to the complete documentation, observe all legal or other safety and accident prevention regulations and the applicable standards and directives in the respective country of operation.

2.2.2 Obligations of operator

Safe working

The operator of the system is responsible for ensuring that the calculator is used only for the intended purpose with due regard for safety and hazards and in compliance with this Installation and User Guide.

The operator must ensure and monitor compliance with the following:

- that the meter is used for the intended purpose
- legal and other safety and accident prevention regulations
- applicable standards and directives of the country of operation

The operator must provide safety equipment.

Personnel qualifications

The operator must ensure that personnel working on the calculator have read and understood this Installation and User Guide and all associated documents, particularly safety and repair instructions, before commencing work.

All work must be performed only by technically trained personnel:

- installation and repair work
- work on the electronic circuits

Safety equipment

Safety equipment must be provided if required.

- E.g. install stop valves before and after the connected flow sensor to simplify removal and installation.

Warranty

- Obtain the manufacturer's approval before carrying out modifications, repair work or changes during the warranty period.
- Use only genuine parts or parts approved by the manufacturer.

2.2.3 Obligations of trained personnel/user

- Observe all instructions in the Installation and User Guide and on the device that are relevant to handling the calculator.
- Use safety equipment if necessary.
- Always disconnect the calculator from the electrical supply before carrying out repair work.

2.3 Specific hazards



DANGER

Do not touch live parts during installation work.

Risk of serious injuries or death!

- ⇒ The calculator installation is only to be performed by an installation and/or electrical contractor.
 - ⇒ Personnel must be trained in the installation of medium-voltage electrical equipment (up to 1000 V).
-



WARNING

Electrostatic discharge.

Risk of damage to calculator and particularly electronic components, for which no liability is accepted!

Observe the relevant ESD (electrostatic discharge) regulations.



CAUTION

Electric and magnetic fields.

Risk of interference with electronic components in the calculator!

- ⇒ Do not install the calculator or the input/output cables near heavy electrical loads or their cables.
 - ⇒ Maintain the exact separation. This depends on the magnitude of the voltage and current of these loads.
 - ⇒ Consult a suitable expert in the event of doubt.
-

3 Product description

3.1 Mechanical design

Fig. A Design of calculator



- 1 LC display
- 2 Pushbutton
- 3 Optical ZVEI interface
- 4 Laser labelling

3.2 Scope of delivery

The scope of delivery for the standard version includes the following:

- Calculator
- Wall mounting set incl. fixing material
- Installation Guide
- Installation kit for temperature sensors

3.3 Labelling

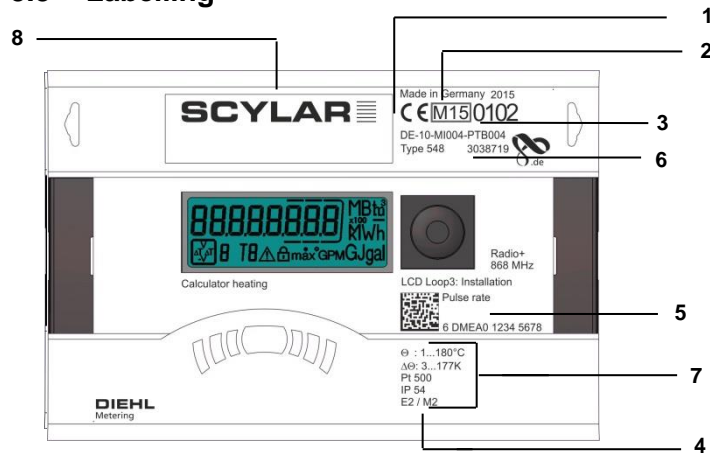

The meter is labelled using a laser.

Fig. B Labelling (example)

- 1 Conformity mark
- 2 Year of declaration of conformity
- 3 EC type examination certificate number
- 4 Year of manufacture
- 5 Calculator serial number
- 6 Calculator article number
- 7 Calculator data
- 8 Product name

3.4 Functional description

The calculator is a fully electronic measuring instrument. It is equipped with a data memory that enables comparison of the previous months' readings with the current readings. The data measured by the calculator are shown in the display. The display is provided with various windows as loop functions that can be called up in succession to display the system information assigned to each window (e.g. energy amounts, water amounts, current temperatures, maximum values).

The calculator has 6 display loops: main loop, accounting date loop, info loop, pulse input loop, tariff loop and monthly value loop. The individual loops are described in Section 8 "Operation". Some windows in a loop and whole display loops can be deactivated separately to make the window structure clearer.

Various display windows comprise up to seven displays that change at intervals of 2 – 4 s.

The loops in the display are numbered from 1 to 6 to help the user find his way around quickly.

The main loop is programmed with the current data as default setting, e.g. for energy, volume, flow rate and other parameters. It is not possible to change the order of the available data.

3.5 Power supply

Possible power supplies:

- A cell, 3.6 V DC lithium battery, with a lifetime of 11 years (standard version, with radio)
- D cell, 3.6 V DC lithium battery, with a lifetime of 20 years
- Mains unit 24 V AC
- Mains unit 230 V AC

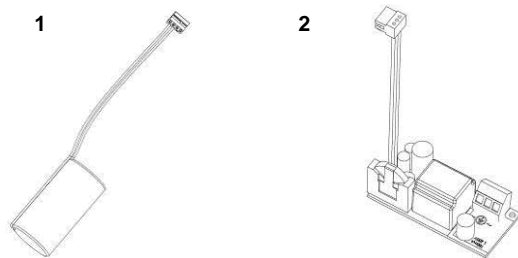

Fig. C Power supplies

- 1 A or D cell, 3.6 V DC lithium battery
- 2 Mains unit 24 V AC / 230 V AC

The various power supplies can be changed in the field.



NOTE

The calculator switches automatically to power save mode if the button is not pressed for approx. 4 minutes. The display is also switched off in this case, but can be switched on again by pressing the button. Communication is maintained, e.g. over the M-Bus or the optical interface. The calculator does not switch to power save mode if an error exists. The error is shown in the display as an error code.

Never connect between two phases if a mains unit is used, as this would destroy the mains unit. The protective safety cover must be installed at all times. The cable is to be fused at max. 6 A and protected against manipulation.

Used batteries must be disposed of at suitable collection points.

3.5.1 Battery

A 3.6 V DC lithium battery is fitted in the standard version. The battery is not to be charged or short-circuited. Ambient temperatures below 40 °C extend the life of the battery.



DANGER

⇒ There is a risk of explosion if the battery is replaced with the wrong type of battery.

3.5.2 Overview of the measuring rates

The following table shows the lifetime of the batteries depending on the standard measuring rates. Customer versions can differ from the standard measuring rates in the measuring rate and battery lifetime.

	Battery lifetime [Years]	Radio sending interval	Measuring rate (independent of radio)	
	A-Cell		Measuring rate	
without radio/without modules	12	-	Volume Temperature	1s 16s
868MHz	11	120s		
434MHz	11	120s		
	D-Cell		Measuring rate	
without radio	16 ¹ (20)	-	Volume Temperature	1s 4s
868MHz	16 ¹ (20)	12s		
434MHz	16 ¹ (20)	12s		
	Mains unit		Measuring rate	
without radio	unlimited	12s	Volume Temperature	1/8s 2s
868MHz	unlimited	12s		
434MHz	unlimited	12s		

¹: Specification in the data sheet, calculation of the value in brackets

²: Specification in the data sheet, calculation of the value in brackets, 20 years for radio off, 18 years for radio on

3.5.3 Mains unit

The mains unit indicates to the calculator if mains voltage is present. If the mains unit fails, the back-up battery (CR2032) in the mains unit provides the power supply for up to 1 year. This back-up battery can be replaced if necessary. The LCD readings (on pressing button) and the date and time are still updated, but none of the measuring functions work, incl. the flow rate measurement. Communication still functions over the optional M-Bus, RS485 and RS232 modules or the optical interface, but this reduces the life of the back-up battery. The integrated radio function is switched off in the event of mains failure.

3.6 Calculator interfaces

The calculator is equipped as standard with a ZVEI optical interface. This is located on the calculator below the display (Fig. D). This interface can be used for communication with the calculator (using the IZAR@SET software) and for checking it.

Communication uses the M-Bus protocol, for which the Bluetooth IZAR OH BT opto head is suitable.

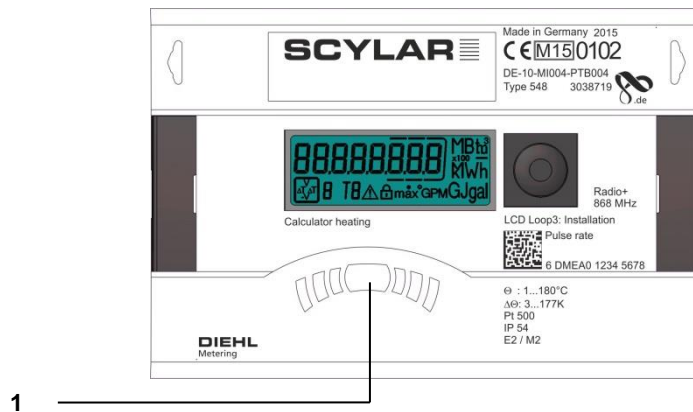

Fig. D Front of calculator

1 Optical ZVEI interface

The calculator has two slots for extension modules, slot 1 and slot 2 (Fig. E).

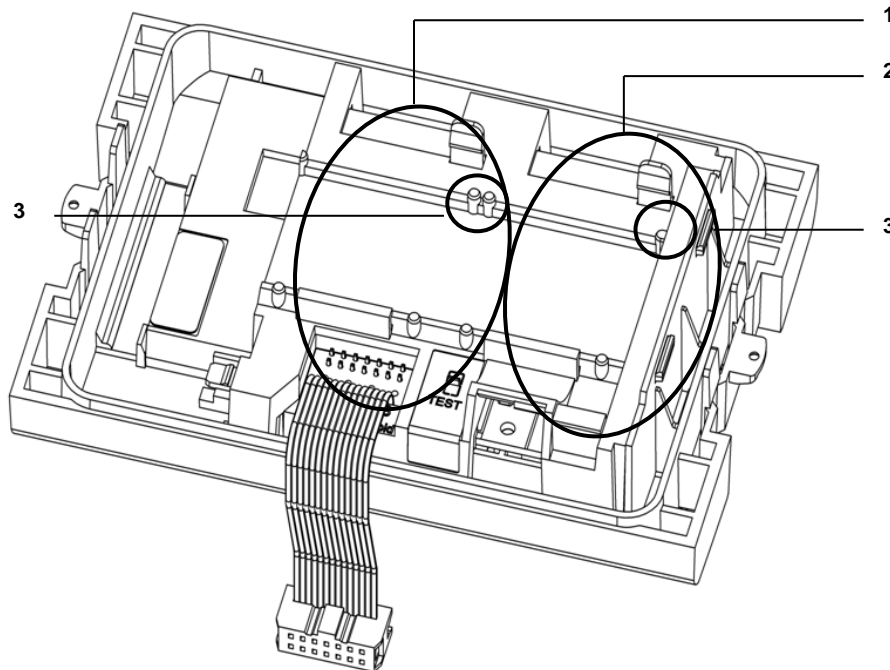

Fig. E Slots

- 1 Slot 1
- 2 Slot 2
- 3 Fixing lugs



NOTE

Inserting a module into slot 2 immediately disables the internal radio function.



NOTE

If other external devices are connected to the calculator, these must be of the safety extra-low voltage (SELV) type and comply with EN 60950-1.

3.6.1 Communication modules

The calculator supports two communication channels over the same or different interfaces. An additional communication module can be used in radio operation.

The protocol is different for each of the two channels and is preset ex works, but can be set to customer-specific requirements using the IZAR@SET software. Each channel has its own primary address, but only one secondary address exists, which is set to the serial number ex works. The calculator is equipped with automatic baud rate detection. Default baud rate is 2400 baud.

M-Bus module

The M-Bus communication module is a serial interface for communication with external devices (M-Bus repeater), e.g. IZAR CENTER. A number of devices can be connected to a control centre. The M-Bus module is electrically isolated.

Communication over radio

The integrated radio function is an interface for communication of predefined protocols with Hydrometer radio receivers. The communication protocol is preset, but can be defined to a customer-specific protocol using the IZAR@SET software. By default, the internal radio is disabled. When the calculator receives in total 10 pulses for the first time on the volume pulse input, the integrated radio is enabled.

RS-232 module

The RS-232 communication module is a serial interface for communication with external devices, e.g. a PC. The transmission speed is 300 or 2400 bauds. A special data cable is required for connecting this module to the PC. (Order no.: 087H0121). The RS-232 module isn't electrically isolated.

RS-485 module

The RS-485 communication module is a serial interface for communication with external devices, e.g. a PC. It can only communicate at a transmission speed of 2400 bauds. The RS-485 module is electrically isolated.

L-Bus module

The L-Bus communication module is a serial interface for communication with an external radio module, in which the M-Bus protocol is transmitted. It can be used for example if the radio range of the internal radio is not enough. The L-Bus module isn't electrically isolated.

3.6.2 Function modules

Pulse output module

This module contains connections for two pulse outputs, which can be programmed as desired using the IZAR@SET software. The energy pulse output is marked as "01 - \perp " on the module and "Out1" in the display. The volume pulse output is marked as "02 - \perp " on the module and "Out2" in the display. The both pulse outputs are electrically isolated.

Pulse input module

This module has 2 pulse inputs for connecting 2 additional pulse meters, such as water meters, gas meters or electricity meters. The possibility of programming the pulse value using the IZAR@SET software enables volume or energy values to be displayed and transmitted remotely over a suitable communication module. Initial meter counts can also be parametrized for these two pulse inputs. The pulse input module isn't electrically isolated.

Combined module

The combined module is equipped with two pulse inputs and a pulse output, which can be programmed as desired using the IZAR@SET software. Pulse input 1 is marked "I1 - \perp " on the module and "IN1" in the display, pulse input 2 "I2 - \perp " on the module and "IN2" in the display. The pulse output is marked "01 - \perp " on the module and "Out1" in the display. The pulse output on this module isn't electrically isolated.

Analogue module

The analogue module has the size of 2 standard modules and has two passive outputs with 4 to 20 mA. If one analogue module is mounted in the meter, no other module can be installed. The internal radio is still working. The connection cable between the main pcb board and the module has to be installed on port 1 (left slot). By default, the two analog outputs are not programmed, the values can be programmed with the help of the software IZAR@SET (standard). The analogue module is electrically isolated.

4 Technical data

4.1 Dimensions

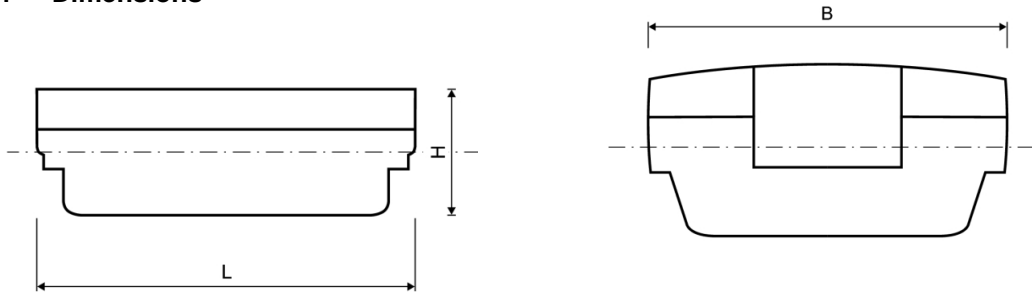

Fig. F Dimensions

SCYLAR INT 8			
Overall length	L	mm	150
Width of calculator	B	mm	100
Height	H	mm	54

4.2 General data

- Volume pulse input:
 - 0,01...10000 L/Imp.
 - 200 Hz max. at pulse duration > 3ms
- Temperature sensor:
 - PT500/PT100 in 2/4 wire
 - There are no wired shortcut necessary
- Ambient temperature: 5 ... 55 °C
- Application:
 - heating: 5 ... 130°C (150°C)
 - cooling: 1 ... 90°C
 - heating with cooling tariff: 1 ... 105 °C

4.3 Power supply

External power supply

230 V AC module / 24 V AC module (Fig. C, item 2, page 10)

- Terminals suitable for wires up to 2.5 mm²
- Electrical isolation
- Frequency 50 Hz
- Power consumption 0.12 VA ±10 %
- Soldered fuse

4.4 Calculator interfaces

4.4.1 Communication modules

M-Bus

- M-Bus module to EN 1434-3 standard
- 2-pole terminal strip with terminals marked "24" and "25"
- Terminals suitable for a cable with 2 wires of 2.5 mm²
- Electrical isolation
- Polarity reversal protection
- Maximum voltage: 50 V DC
- Current drawn: one M-Bus load
- Primary or secondary addressing
- Baud rate 300 or 2400 bauds (automatic baud rate detection)
- Protocol: M-Bus

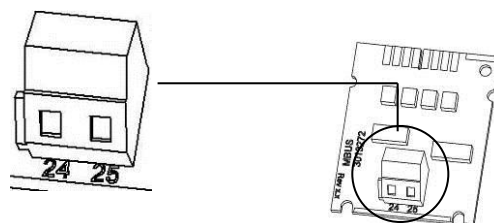

Fig. G M-Bus module

Communication over integrated radio module

Communication has the following specification:

- Unidirectional transmission
- The module sends every 8 ... 256 s (variable, depending on protocol length)
- Data actuality: online – no time delay between recording readings and data transfer
- The integrated radio module always accesses the current meter counts
- Transmission frequency: 868 MHz or 434 MHz
- Various Hydrometer receivers are available for receiving the protocol (e.g. Bluetooth, GPRS, LAN, ...)
- Encrypted protocol: Real Data Radio or Open Metering
- Reading modes: walk-by, drive-by, fixed network

RS-232

- Terminals suitable for a cable with 3 wires of 2.5 mm²
- Protocol: M-Bus
- Transmission speed: 300 or 2400 bauds
- Electrical isolated

The module contains a 3-pole terminal strip with terminals marked 62 (Dat), 63 (Req) and 64 (GND). A special adapter cable is required for connection (order no. 087H0121). The coloured wires are to be connected as shown:

62 = brown
63 = white
64 = green

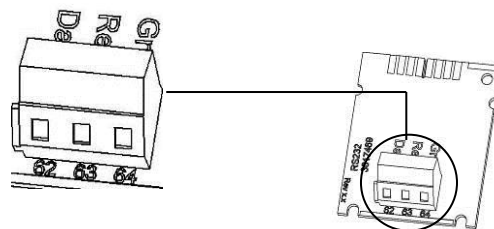

Fig. H RS-232 module

RS-485

- Terminals suitable for a cable with 4 wires of 2.5 mm²
- Protocol: M-Bus
- Transmission speed: 2400 bauds
- Electrical isolated

The module contains a 4-pole terminal strip with terminals marked “D+”, “D-”, “+12V” and “-12V”. The module requires an external power supply of 12 V DC ±5 V.

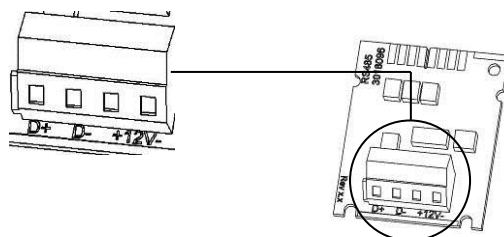

Fig. I RS-485 module

L-Bus

- 2-pole terminal strip with terminal marked „Dat“ and „⊥“
- Terminals suitable for a cable with 2 wires of 2,5 mm²
- Maximum voltage: 50 V DC
- Primary or secondary addressing
- Baud rate 300 or 2400 bauds(automatic baud rate detection)
- Protocol: M-Bus
- Not electrical isolated

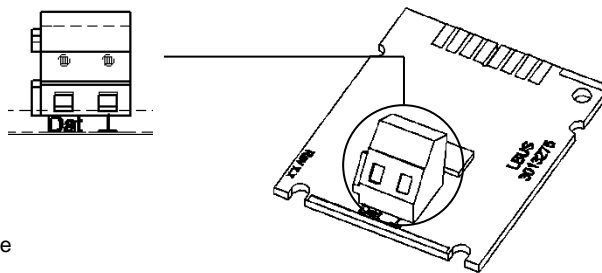

Fig. J L-Bus module

4.4.2 Function modules

Pulse input module

- The two pulse inputs can be programmed independently of each other with values of 1, 2.5, 10, 25, 100, 250, 1000 or 2500 litres per pulse.
- Possible units are all the energy units available in the meter, such as kWh/pulse and GJ/pulse, but also volume units like l/pulse, m³/pulse or no units.
- The input frequency is in the range 0 – 8 Hz, min. pulse duration 10 ms
- Input resistance 2.2 MΩ
- Terminal voltage 3 V DC
- Cable length ≤ 10 m
- Electrical isolated

Pulse input 1 is marked “I1 - ⊥” on the module and “IN1” in the display, pulse input 2 “I2 - ⊥” on the module and “IN2” in the display.

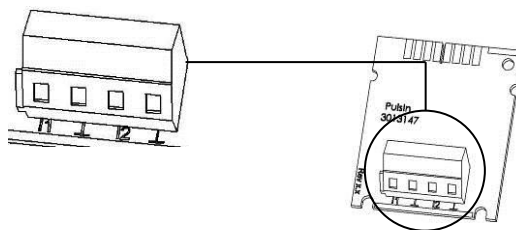

Fig. K pulse input module

Pulse output module

- External power supply $V_{CC} = 3 - 30 \text{ V DC}$
- Output current $\leq 20 \text{ mA}$ with a residual voltage of $\leq 0.5 \text{ V}$
- Open collector (drain)
- Output 1:
 - Frequency: $\leq 4 \text{ Hz}$
 - Pulse duration: $125 \text{ ms} \pm 10 \%$
 - Pulse break: $\geq 125 \text{ ms} - 10 \%$
- Output 2:
 - Frequency $\leq 100 \text{ Hz}$
 - Pulse duration/pulse break: $\sim 1:1$
- Volume pulse value is programmable as desired (default: last digit in display)
- Floating contact (electrically isolated)

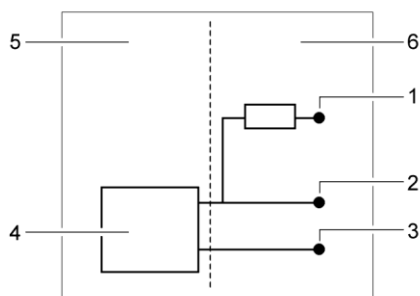

Fig. L Connection diagram for pulse output

- 1 V_{CC}
- 2 Pulse
- 3 GND
- 4 Pulse output module
- 5 Calculator
- 6 External connecton

The outputs are marked "01 - \perp " and "02 - \perp " on the terminal strip and "Out1" and "Out2" in the display.

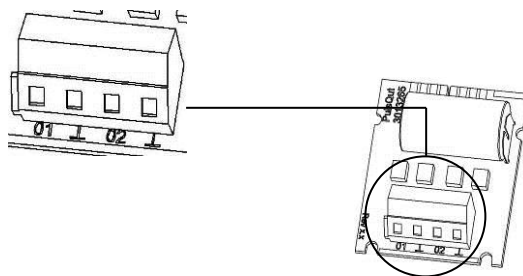

Fig. M Pulse output module

Combined module

The combined module is equipped with 2 pulse inputs and 1 pulse output.

The pulse inputs have the following specification:

- The two pulse inputs can be programmed independently of each other with values of 1, 2.5, 10, 25, 100, 250, 1000 or 2500 litres per pulse.
- Possible units are all the energy units available in the meter, such as kWh/pulse and GJ/pulse, but also volume units like l/pulse, m³/pulse, or no units.
- The input frequency is in the range 0 – 8 Hz, min. pulse duration 10 ms
- Input resistance 2.2 MΩ
- Terminal voltage 3 V DC
- Cable length < 10 m

The pulse output has the following specification:

- External power supply $V_{cc} = 3 - 30$ V DC
- Output current ≤ 20 mA with a residual voltage of ≤ 0.5 V
- Open collector (drain)
- Output frequency ≤ 4 Hz
- Pulse duration: 125 ms ± 10 %
- Pulse break: ≥ 125 ms -10 %
- Volume pulse value is programmable as desired (default: last digit in display)
- No floating contact (not electrically isolated)

Pulse input 1 is marked “I1 - \perp ” on the module and “IN1” in the display, pulse input 2 “I2 - \perp ” on the module and “IN2” in the display (Fig. N, item 1).

The pulse output is marked “O1 - \perp ” on the terminal strip and “Out1” in the display (Fig. N, item 2).

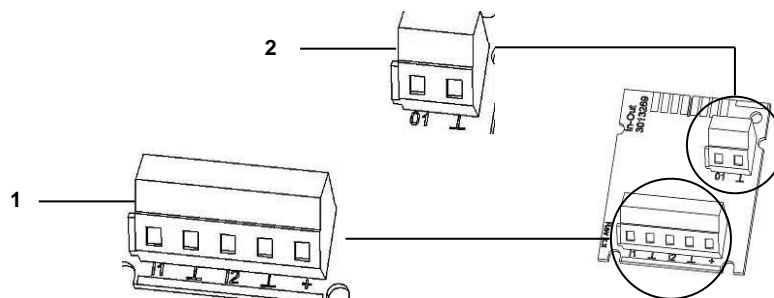

Fig. N Combined module

- 1 Terminals for pulse inputs
- 2 Terminals for pulse output

Analogue output module

- 2 passive outputs
- External power supply: 10 ... 30 V DC
- Current loop 4 ... 20 mA
where 4 mA = 0 value; 20 mA = programmed max. value
- Overload up to 20.5 mA, then fault current
- Errors are generated at 3.5 mA or 22.6 mA (programmable)
- Output values: power, flow rate, temperatures
- Electrical isolated

The outputs are marked “1” and “2” on the terminal strip with the respective polarity “+” and “-”.

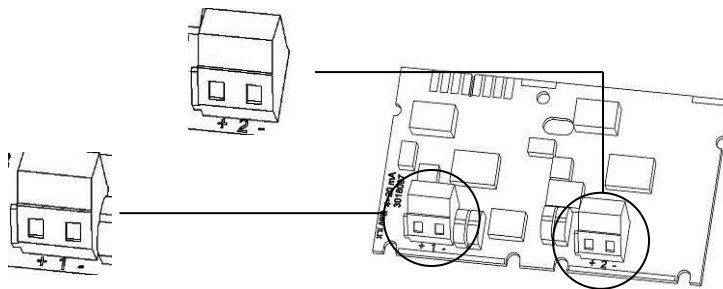

Fig. O Analogue module

4.4.3 Test output

The test output located on the side of the main electronics assembly is for use by test centres (Fig. P).

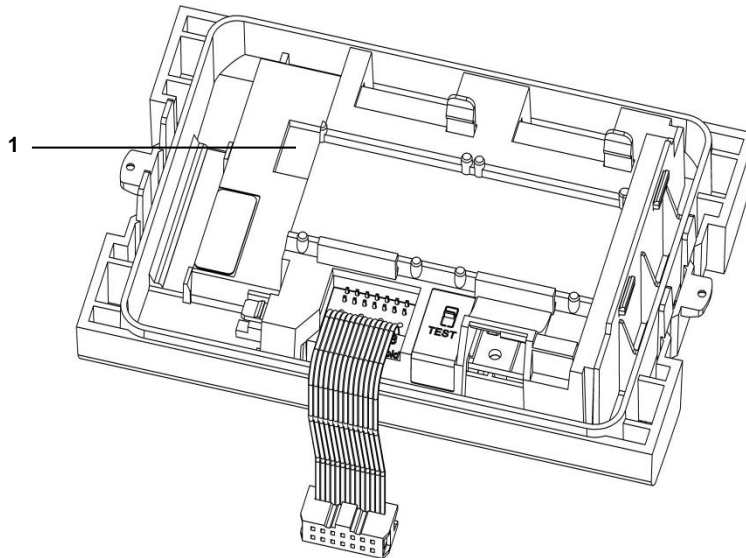

Fig. P Test output

1 Connection for test cable

Two special cables are required for testing:

1. Test cable for volume test pulses (not electrically isolated) (Order. Nr. 3024794)
2. Test cable for energy test pulses (not electrically isolated) (Order Nr. 3024799)

Other specifications (pulse value, pulse duration/break, pulse frequency) can be obtained from the Inspection and Test Instruction.

5 Transport, storage

5.1 Unpacking the calculator

Calculators are measuring instruments and must be handled carefully. To protect against damage and soiling, they should not be removed from the packaging until shortly before installation.

5.2 Transporting the calculator

The calculator is only to be transported in its original packaging.

5.3 Storage of calculator

- The meter must be stored in a dry place.
- Storage temperature -20 °C ... +60 °C
- Relative ambient humidity < 93 %

6 Installation



NOTE

This installation guide is intended for trained personnel and does not contain any basic working steps.

The calculator may only be installed in dry and frost-free areas in buildings.

Avoid sharp edges (thread, flange, measuring tube). Only install and remove the meter when the system is not under pressure.

Important! The seal on the calculator (Fig. Q, page 26) must not be damaged! A damaged seal immediately invalidates the factory warranty and the verification or declaration of conformity. The cables supplied with the meter must not be shortened or changed in any other way.

Live parts may be exposed when opening covers or removing parts. Connection points may also be live.

The regulations covering the use of energy meters / calculators and electrical installations must be observed!

All instructions listed in the installation guide for the calculator must be observed.

The specified medium temperature is 5 ... 130 °C (150 °C). The temperature range depends on variant and application. The sealed variant of a connected flow sensor is to be used if condensation is expected.

Only water without additives may be used as medium, used to AGFW leaflet FW510 (Exception: Specifically programmed meter for medium Tyfocor LS). The calculator must be removed from connected flow sensor at a medium temperature over 90 °C or if the water temperature is lower than the ambient temperature.

The IZAR@SET software is used for reading/parametrization and is obtainable on the Internet at <http://www.hydrrometer.de>.



DANGER

Do not touch live parts during installation work.

Risk of serious injuries or death!

- ⇒ The calculator installation is only to be performed by an installation and/or electrical contractor.
- ⇒ Personnel must be trained in the installation of medium-voltage electrical equipment (up to 1000 V).

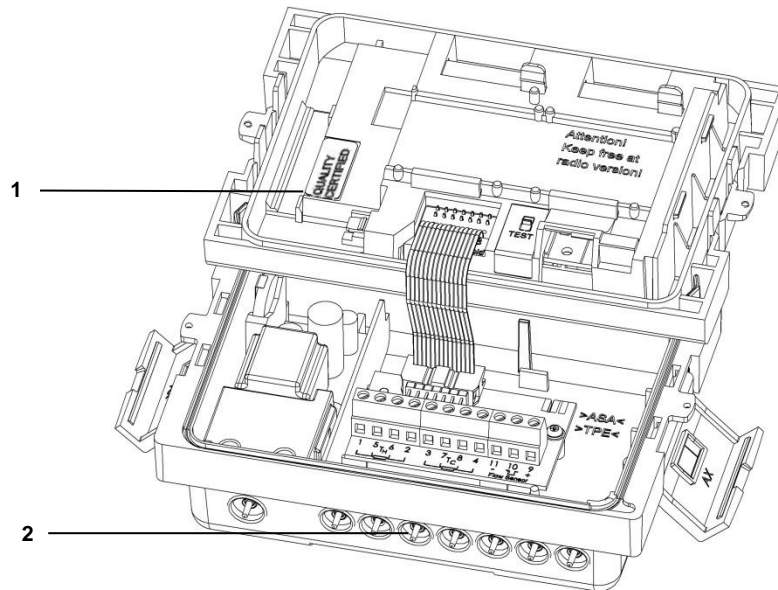

Fig. Q Seals

- 1 Seals
- 2 Cable bushings

6.1 Installation



CAUTION

If medium temperature is lower than ambient temperature!

Risk of damage to calculator due to condensation.

- ⇒ Use the sealed variant of a connected flow sensor
- ⇒ Remove calculator from the flow sensor (Fig. S, page 28).



NOTE

Install the calculator in an accessible position for service and operating personnel.

It is recommended that stop valves be fitted before and after the calculator connected to the flow sensor to simplify removing the calculator.

6.1.1 Installing the calculator

- ✓ Make sure the calculator is sufficiently far away from possible sources of electromagnetic interference (switches, electric motors, fluorescent lamps, etc.).
- ⇒ Installation at medium temperature $< 90\text{ }^{\circ}\text{C}$ or at $T_{\text{Water}} > T_{\text{Ambient}}$: If necessary install the calculator the flow sensor (Fig. S, page 28) or mount the calculator on the wall (Fig. R).

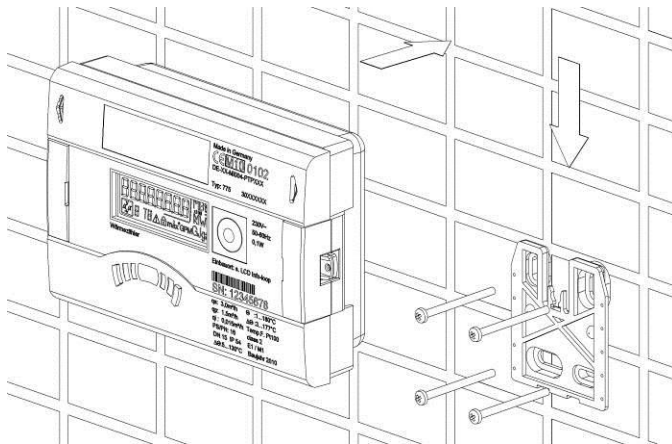

Fig. R Install the calculator on the wall

⇒ Installation at medium temperature $> 90\text{ °C}$ or at $T_{\text{Water}} < T_{\text{Ambient}}$ (application as calculator for cooling or calculator for heating with cooling tariff). Install the calculator remotely at a sufficient distance away from heat sources (Fig. S), e.g. on the wall (Fig. T, page 29). A wall holder (Fig. U, item 1, page 29, supplied with meter) or a spacer holder (Fig. U, page 29, optional) is available for this purpose.

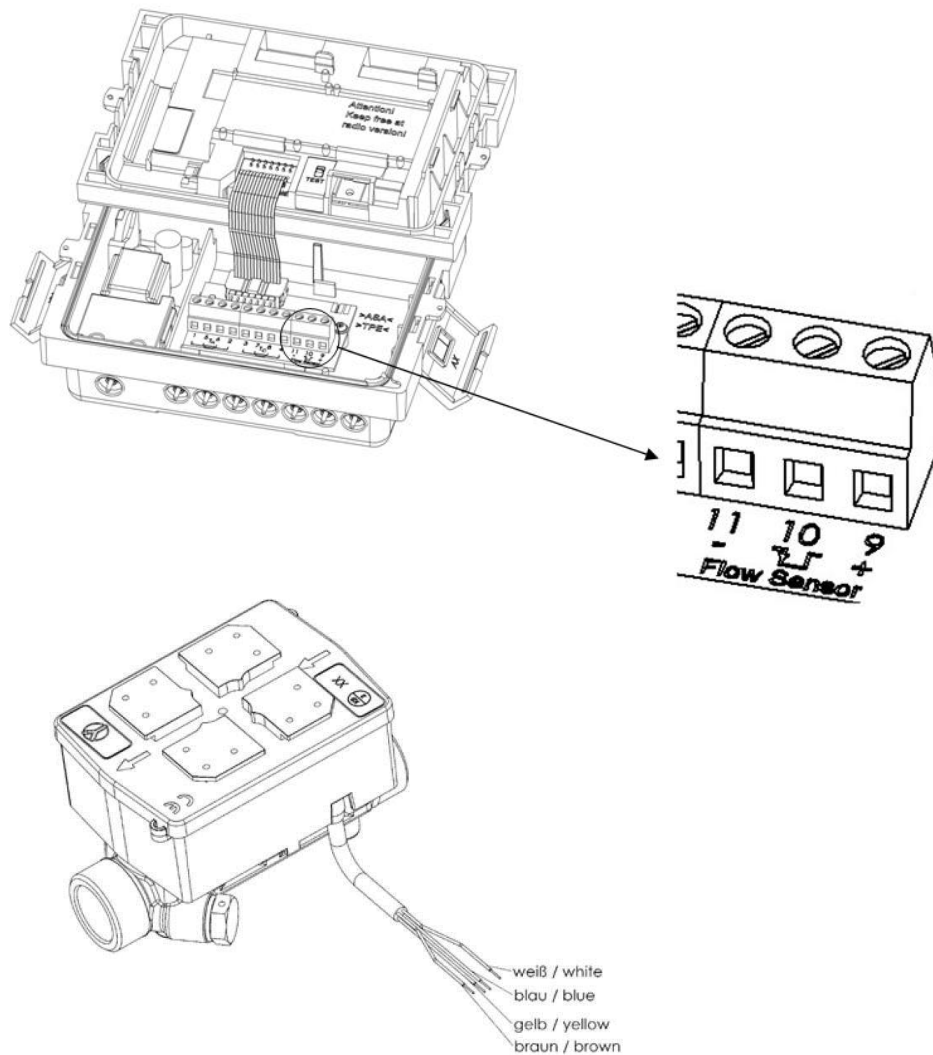

Fig. S Calculator deposited with a connected flow sensor SHARKY FS 473

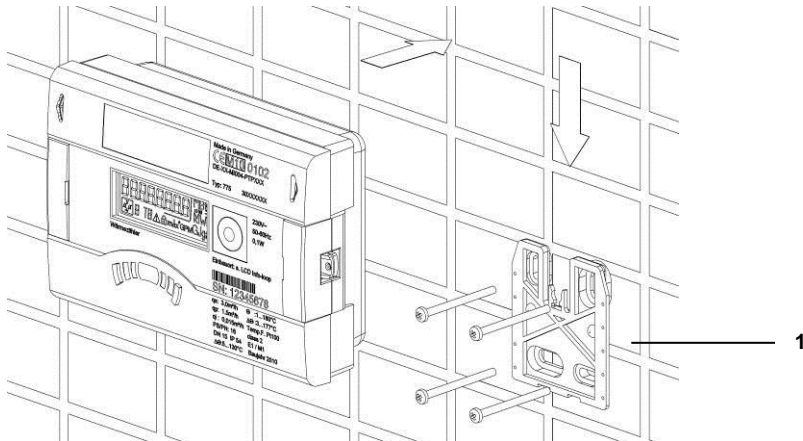

Fig. T Wall mounting

1 Wall holder (supplied with calculator)

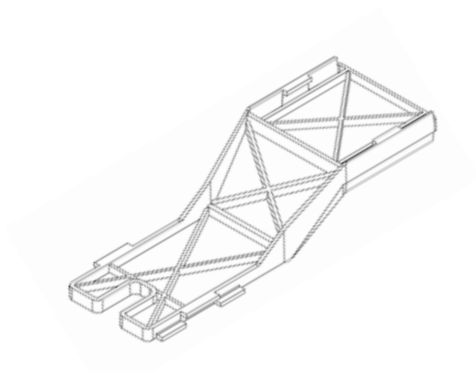

Fig. U Spacer holder (not supplied with calculator)

Example:

Volume pulse input and power supply for flow sensor

⇒ Connection of flow sensor with pulse input and if required with voltage supply on clamp 9 (+Vcc), 10 (Flow Pulse), 11 (-Gnd) of calculator.

Flow sensor connection	Calculator terminal
Vcc external 3,6 V	9 (+)
Flow pulse input (open collector)	10
Ground	11 (-)

Example:

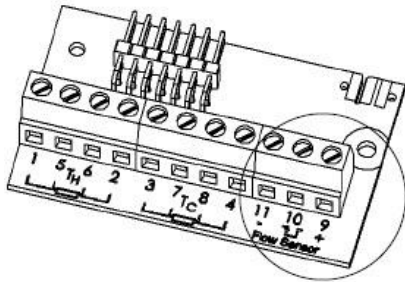

Pulse frequency ≤ 200 Hz
Pulse duration > 3 msec
Pulse value in the display

Fig. V Calculator terminal

Example:

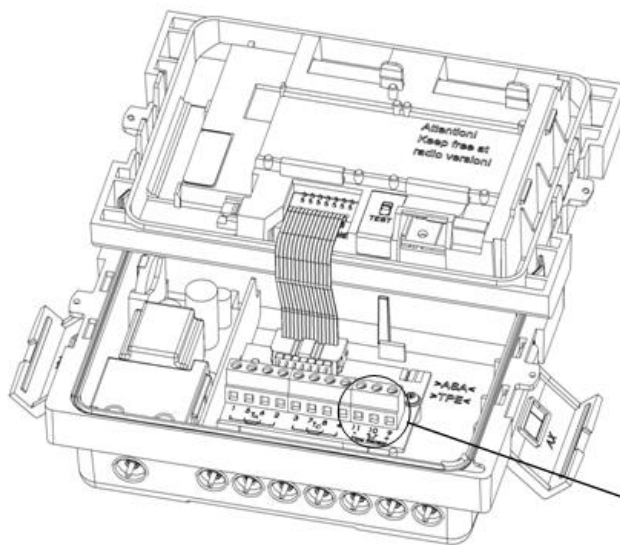

SHARKY FS 473	Calculator terminal
Vcc (brown)	9 (+)
Pulse (white)	10
GND (blue)	11 (-)

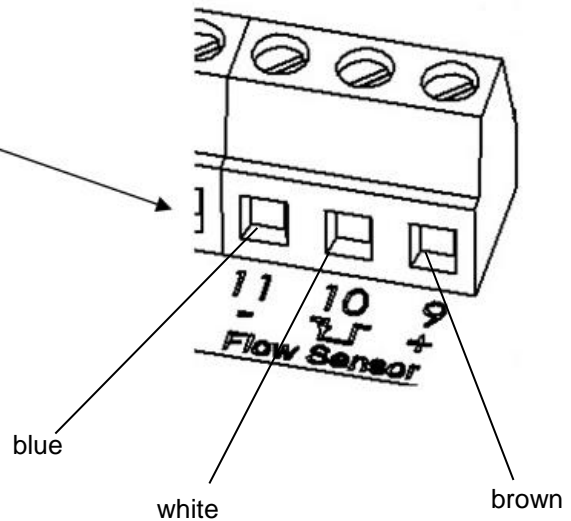
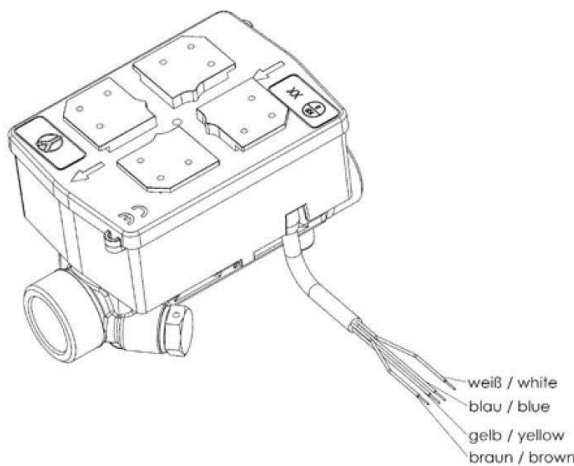
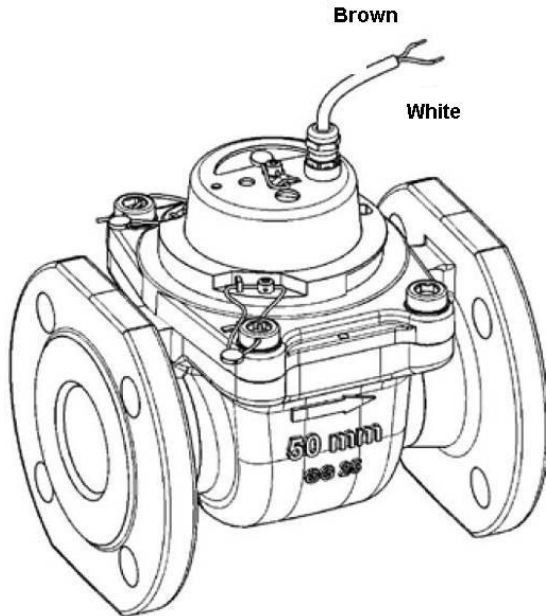

Fig. W Calculator deposited with a connected flow sensor SHARKY FS 473

Example:

Calculator with a connected mechanical flow sensor (here: WESAN WP 222)



Hydrometer Reed Switch

Switch(Reed)	Calculator terminal
Pulse (white)	10
GND (brown)	11 (-)

Fig. X WESAN WP 222 with reed switch

6.1.2 Connecting temperature sensor



NOTE

The calculator is operated with separately approved pairs of Pt 100 or Pt 500 temperature sensors. The type of sensor to be used is printed on the front of the calculator. Ensure that the approved temperature range of the temperature sensors is the same as the temperature range of the calculator!

- Handle the temperature sensors carefully!
- The sensor cables are fitted with coloured type labels:
 - Red: sensor in hot line
 - Blue: sensor in cold line

1. Feed the sensor cables through the cable entries (Fig. Y).

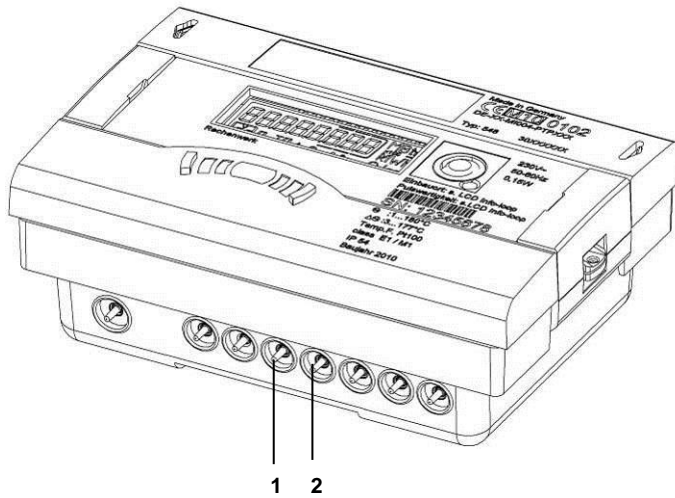

Fig. Y Cable entries

- 1 Cable entry for connecting T_{Hot} (5, 6)
- 2 Cable entry for connecting T_{Cold} (7, 8)

2. There are no contact bridges necessary!

3. Connect the sensor cables to the following table:

- For 2-wire connection to terminal 5-6 and 7-8 (Fig. Z, page 33).
- For 4-wire connection to terminal 1/5 - 6/2 and 3/7 - 8/4 (Fig. Z, page 33).

Meter type	Sensor marking	2-wire Terminal	4-wire Terminal	Installation position
Heat meter in return line	Red	5 T_{Hot} 6	1/5 T_{Hot} 6/2	high temperature
	Blue	7 T_{Cold} 8	3/7 T_{Cold} 8/4	low temperature
Heat meter in forward line	Red	5 T_{Hot} 6	1/5 T_{Hot} 6/2	high temperature
	Blue	7 T_{Cold} 8	3/7 T_{Cold} 8/4	low temperature
Cooling meter in return line	Blue	7 T_{Cold} 8	3/7 T_{Cold} 8/4	high temperature
	Red	5 T_{Hot} 6	1/5 T_{Hot} 6/2	low temperature
Cooling meter in forward line	Blue	7 T_{Cold} 8	3/7 T_{Cold} 8/4	high temperature
	Red	5 T_{Hot} 6	1/5 T_{Hot} 6/2	low temperature
Heating / Cooling meter in return line	Red	5 T_{Hot} 6	1/5 T_{Hot} 6/2	high temperature
	Blue	7 T_{Cold} 8	3/7 T_{Cold} 8/4	low temperature
Heating / Cooling meter in forward line	Red	5 T_{Hot} 6	1/5 T_{Hot} 6/2	high temperature
	Blue	7 T_{Cold} 8	3/7 T_{Cold} 8/4	low temperature

Red: sensor in hot line, Blue: sensor in cold line.

The programmed installation position is shown in the info loop (loop 3).

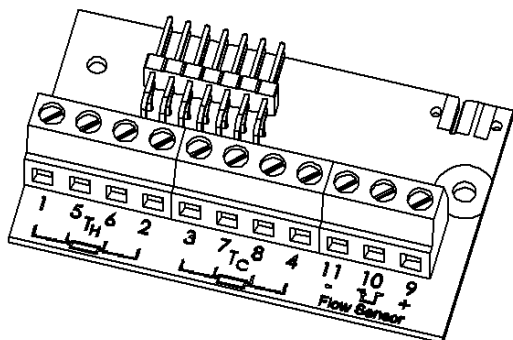

Fig. Z Terminals for temperature sensors

4. Press the sensor cables into the strain relief.
5. Connect the top part to the bottom part.

6.1.3 Installing the temperature sensor



NOTE

The temperature sensors are to be installed symmetrically in the forward and return line and preferably direct. The free temperature sensor can be installed in a ball valve or in a pocket conforming to the requirements for this type of sensor. The forward and return sensors must be inserted as far as the bottom of the pocket and then fixed in position. For installation in a ball valve, a 5-piece coupling set is enclosed with the meter in a separate bag. Bores in the flow sensor can be used for symmetrical installation of the temperature sensors. In Germany, sensors up to nominal pipe diameters of 25 mm are to be installed directly immersed.

If the temperature sensors are connected permanently, the cables must not be shortened or lengthened. If replaceable conformity-marked temperature sensors are used, the connecting cables must have the same length for the forward and return line and not exceed 10 m; the cross-sections of the cables must comply with EN 1434-2. They are connected to the marked Pt 100 or Pt 500 terminals in line with the electrical compatibility of the integrator and finally sealed. The connecting cables of the temperature sensors must be as short as possible. These cables are not to be laid together with mains supply cables in cable ducts or cable racks. The minimum separation of 50 mm for low-voltage cables must be maintained in accordance with EN 1434-6.

Installation possibilities:

- Installation in a ball valve with adapter (5-piece coupling set in separate bag)
- Installation in a pocket

Installation in a ball valve with adapter

Use ball valves suitable for temperature sensor installation with M10 x 1.

1. Close the ball valve.
2. Unscrew the plug screw from the ball valve.
3. Place an O-ring from the enclosed coupling set on the mounting pin (Fig. AA, item 2).

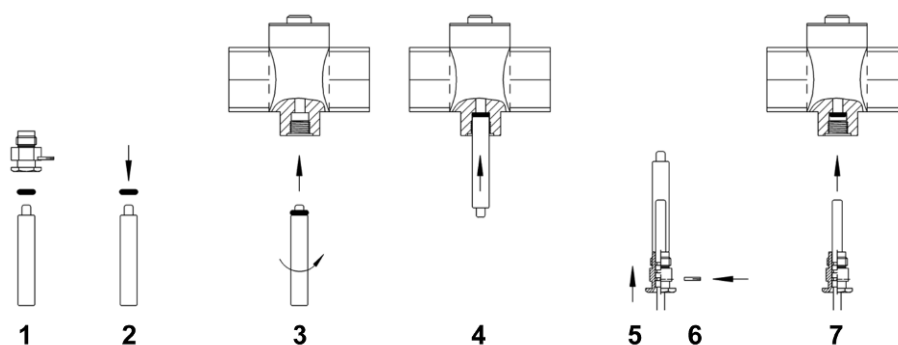

Fig. AA Installing the temperature sensor

4. Insert the O-ring with the mounting pin in the sensor hole of the ball valve using turning movements (Fig. AA, item 3).
5. Position the O-ring in its final position using the other end of the mounting pin (Fig. AA, item 4).
6. Push the fixing screw onto the temperature sensor.
7. Place the mounting pin with the sleeve end over the temperature sensor as far as it will go.
8. The temperature sensor is held in the fixing screw.
9. Press in the slotted pin on the temperature sensor coupling using a pair of pliers (Fig. AA, item 6).
10. Remove the mounting pin from the temperature sensor (Fig. AA, item 5).
11. Now insert the temperature sensor with the adapter coupling into the ball valve and tighten the brass or plastic screw by hand (2-3 Nm) (Fig. AA, item 7).

Installation in a pocket

The pockets are best installed in T-pieces with a 45 ° or 90 ° angle. The tip of the pocket must point in the opposite direction to the direction of flow and must be located in the middle of the pipe (Fig. BB, item 1-5). The temperature sensors must be sealed after installation in the pockets.

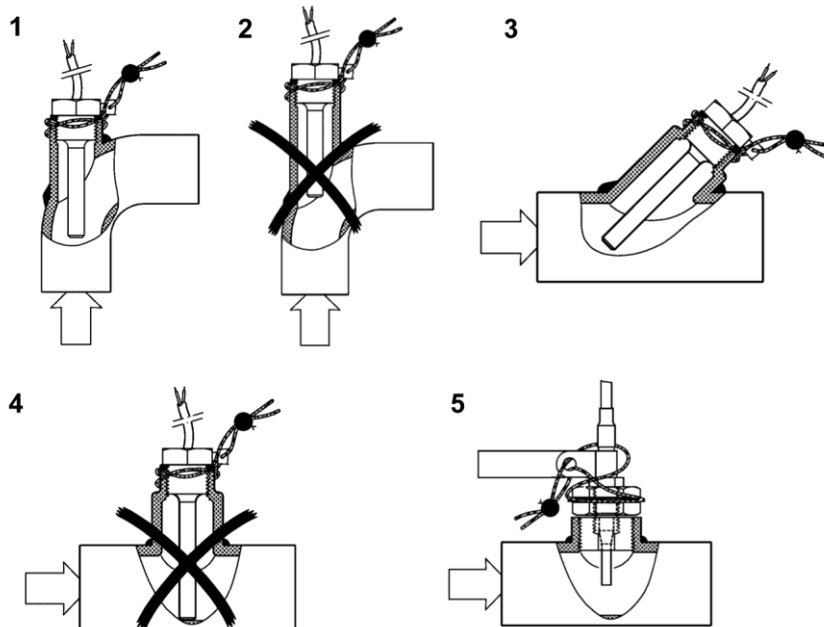

Fig. BB Installation in a pocket

6.2 Installing extension modules



CAUTION

Do not insert modules in the wrong slots.

Risk of damage to calculator!

⇒ Install modules in the correct slots.



NOTE

These modules have no effect on consumption recording and can be fitted retrospectively without damaging the verification mark.



NOTE

Inserting a module into slot 2 immediately disables the internal radio function.

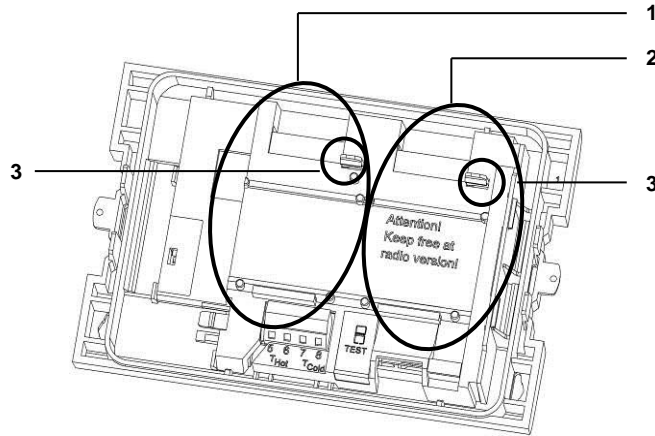

Fig. CC Slots

- 1 Slot 1
- 2 Slot 2
- 3 Fixing lugs

The calculator has two slots for extension modules.

Overview of the possible combinations for the modules

		Slot 2							
		M-Bus	RS232	RS485	Pulse input	Pulse output	Pulse in-/output	Integrated radio	L-Bus (for external radio)
Slot 1	M-Bus	•	•	•	•	•	•	•	•
	RS232	•	•	•	•	•	•	•	•
	RS485	•	•	•	•	•	•	•	•
	Pulse input	•	•	•	-	•	-	•	•
	Analogue output	-	-	-	-	-	-	•	-
	Pulse in-/output	•	•	•	-	-	-	•	•
	L-Bus (for external radio)	-	-	-	-	•	-	•	-

- Combination is allowed
- Combination is not allowed

The modules can be used and combined as shown in the above table. The analogue module occupies both slots. These modules have no effect on consumption recording and can be fitted retrospectively without damaging the verification mark.

WARNING



Electrostatic discharge.

Risk of damage to meter and particularly electronic components, for which no liability is accepted!

Observe the relevant ESD (electrostatic discharge) regulations. No liability is accepted for damage (especially to electronic components) resulting from failure to comply with the ESD regulations.

1. Remove the seal from the calculator housing and open the calculator by releasing the side catches.
2. Take the top part of the calculator and turn it so that the inside of the calculator is facing you. You can simplify installing the modules by using the two openings in the top part to place this on the bottom part (Fig. DD, item 1).

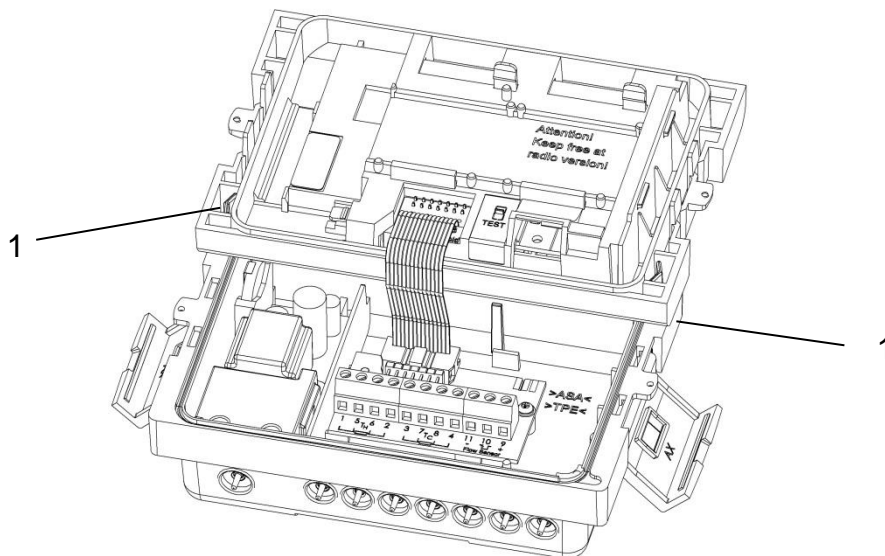

Fig. DD Installation position of top part

- 1 Openings in the top part for placing on the bottom part
3. Insert the module in the relevant slot (Fig. CC, page 36), secure with the fixing lugs and carefully connect the pre-formed ribbon cable at both ends.
4. Now remove the top part from the installation position, turn it and replace it in the correct position on the bottom part of the calculator.
5. Check the calculator for correct operation before sealing the housing cover. The calculator is equipped with automatic detection for detecting which module is inserted in each slot (port). The detection result is shown in loop 3 of the display in two different sequences (windows) for port 1 and port 2. This display automatically changes between "Port 1" and "Port 2" and the relevant module number.

6.2.1 Display of the slot configuration

The Calculator SCYLAR INT 8 is equipped with an automatic detection which module is mounted in which slot (port). This detection will be shown in the display in loop 3 in two different sequences for port 1 resp. port 2. The two sequences will be shown alternating.



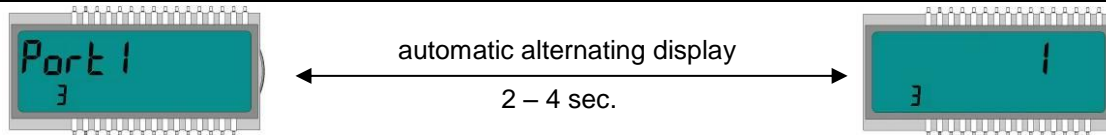

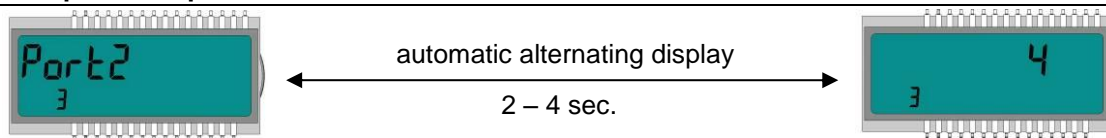

Example slot 1:





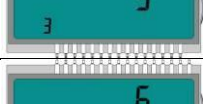

Beispiel Steckplatz 2:



Module detection:

Module type	Display indication
no module	
M-Bus	
RS232	
RS485	
Pulse input	
Pulse output	
Analogue output	

Module type	Display indication
-------------	--------------------

Combined Pulse in-/ output	
Test cable energy	
Test cable volume	
L-Bus (for external radio)	

6.3 Connecting modules

6.3.1 Connecting communication modules

M-Bus module



NOTE

The board contains a 2-pole terminal strip with terminals marked 24, 25 (Fig. G, page 17).

⇒ Connect the M-Bus Master to the marked terminals.

RS-232 module



NOTE

The board contains a 3-pole terminal strip with terminals marked 62 (TX), 63 (RX) and 64 (GND) (Fig. H, page 18).

A special adapter cable is required for connecting to a PC (order no. 087H0121).

⇒ Connect the coloured wires as follows: 62 = brown; 63 = white; 64 = green.

RS-485 module



NOTE

The board contains a 4-pole terminal strip with terminals marked “D+”, “D-”, “+12V” and “-12V” (Fig. I, page 18). The module requires an external power supply of 12 V DC ± 5 V.

⇒ Connect the cable to the marked terminals.

L-Bus module



NOTE

The board contains a 2-pole terminal strip with terminals marked „Dat“ and „⊥“ (Fig. J, page 19).

⇒ Connect the cable of the external radio module with the marked terminals.

6.3.2 Connecting function modules

Pulse input module



NOTE

The board contains a 4-pole terminal strip with terminals marked “I1 - ⊥” and “I2 - ⊥” (Fig. K, page 19).

⇒ Connect the cable for pulse input 1 to terminals “I1 - ⊥” and the cable for pulse input 2 to terminals “I2 - ⊥”.

Pulse output module



NOTE

The board contains a 4-pole terminal strip with terminals marked “O1 - ⊥” and “O2 - ⊥” (Fig. M, page 20).

⇒ Connect the cable for pulse output 1 to terminals “O1” and “⊥” and for pulse output 2 to terminals “O2” and “⊥”.

Combined pulse input and output module



NOTE

The board contains a 5-pole terminal strip for the two pulse inputs with terminals marked “I1 - ⊥” and “I2 - ⊥”. A 3 V DC voltage is connected to the “+” terminal and can be used as the supply for a flow sensor. A 2-pole terminal strip is also provided for the pulse output with terminals marked “O1 - ⊥” (Fig. N, page 21).

⇒ Connect the cable for pulse input 1 to terminals “I1 - ⊥” and the cable for pulse input 2 to terminals “I2 - ⊥”.

⇒ Connect the cable for the pulse output to terminals “O1” and “⊥”.

Analogue output module



NOTE

The board contains two 2-pole terminal strips for the two analogue outputs; output 1 is marked “+ 1 –” and output 2 “+ 2 –” (Fig. O, page 22).

- ⇒ Connect the cable for analogue output 1 to the terminals marked “+” and “-” of terminal strip 1. Connect the cable for the second analogue output to the terminals marked “+” and “-” on terminal strip 2. Observe the correct polarity.

6.4 Connecting the mains voltage 230 V / 24 V



DANGER

Before you connect the mains cable, be sure that no mains voltage is existing.

Risk of serious injuries or death!

Please take care that the mains voltage corresponds to the mounted mains unit.

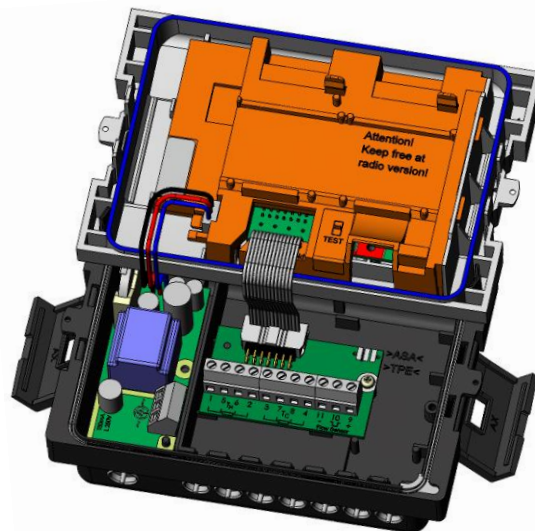

Fig. EE Meter with mains unit

1. Remove the top part of the calculator
 2. Dismount the terminal cover of the mains unit
 3. Install the mains cable into the bottom part of the calculator
 4. Connect the cable according the labelling of the terminal
 5. Reinstall the terminal cover
 6. Mount the top part of the calculator back
 7. Turn on the mains voltage again
- ⇒ Error E - 8 disappears automatically from the display when the mains voltage is available.

6.5 Programming the calculator



NOTE

A number of settings can be programmed in the calculator using the IZAR@SET software. More information is available at www.hydrometer.de.

7 Taking into operation

The calculator can be taken into operation together with the connected flow sensor once it has been installed.

Proceed as follows:

- Open the stop valves.
- Check the system for leaks.
- Carefully bleed the system.
- Check the flow rate and temperature displays for plausibility.
- Bleed the system until the flow rate display is steady. Regulate the system using the flow rate display.
- Seal the sensors.
- Attach the seals to the calculator and temperature sensors.
- Read the meter counts for energy, volume and operating hours.

Error messages for wrong installation:

Error display	Meaning
E – 3	Temperature sensors reversed during installation or connection.



NOTE

If the system is idle, these error messages can appear even though the installation has been carried out correctly.

8 Operation

8.1 Display

The calculator readings are displayed with units and symbols on an 8-digit LCD.

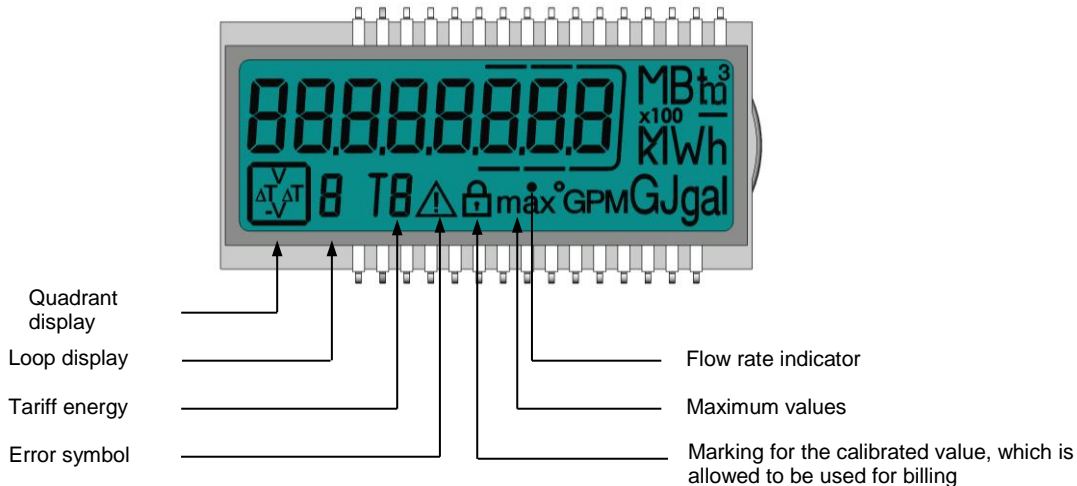

8.2 Operation of calculator

A pushbutton mounted on the front of the calculator is used to switch to the various displays.

To show the data read out by the integrator in the display, various windows have been created as loop functions that can be called up in succession to display the system information assigned to each window (e.g. amount of energy, operating hours, volume of water, current temperatures, ...).

The calculator has 6 different display loops: main loop, accounting date loop, info loop, impulse loop, tariff loop and monthly value loop.

The window content of each loop is programmed with the standard information ex works. Various display windows comprise up to seven displays that change at intervals of 2 – 4 s. The loops in the display are numbered from 1 to 6 to help the user find his way around quickly (Fig. FF). The main loop (1) is programmed with the current data as default setting, e.g. for energy, volume, flow rate.

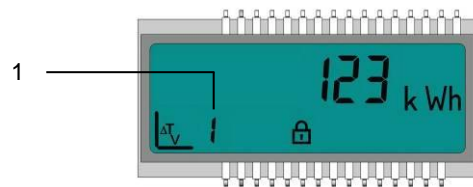

Fig. FF LC display

1 Loop display (for loop 1)

The basic display shows the “Energy” window in the main loop (sequence 1.1). See Section 8.3 Display indications (default settings).

The loop settings can be programmed to suit customer-specific requirements using the IZAR@SET software.

The pushbutton is used to switch through the various displays. The button can be pressed for a short or long time.

The following table shows the possible uses of the button:

Action	Result
Short press => ▼ (< 3 seconds)	Switches to the next display within a loop
Long press (> 3 seconds)	Switches to the next display loop
Button not pressed for 4 minutes	Calculator switches off the display automatically (to save power, but only if no error exists)
Button pressed again	Calculator shows the basic display

8.3 Display indications (default settings)

Main loop (1)

Sequence Window 1

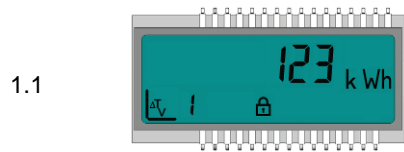

Accumulated energy

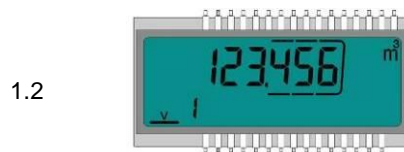

Volume

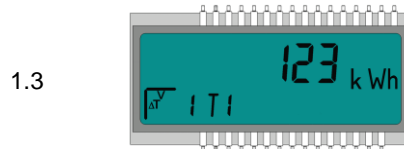

Accumulated energy (cooling)

(Sequence only in a calculator for heating with cooling tariff)

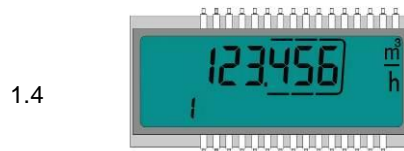

Flow rate

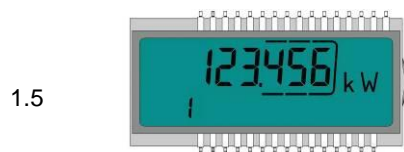

power





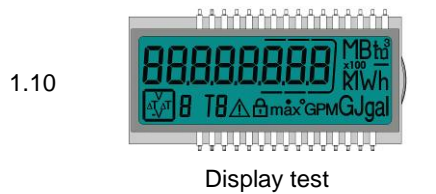
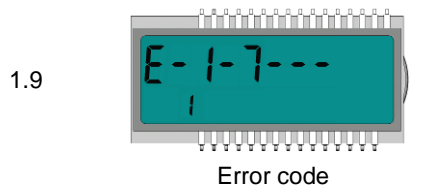
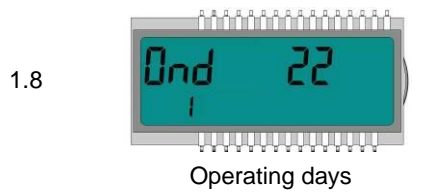
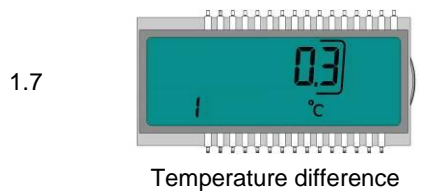
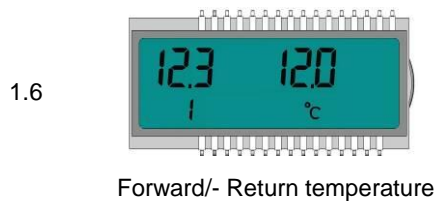





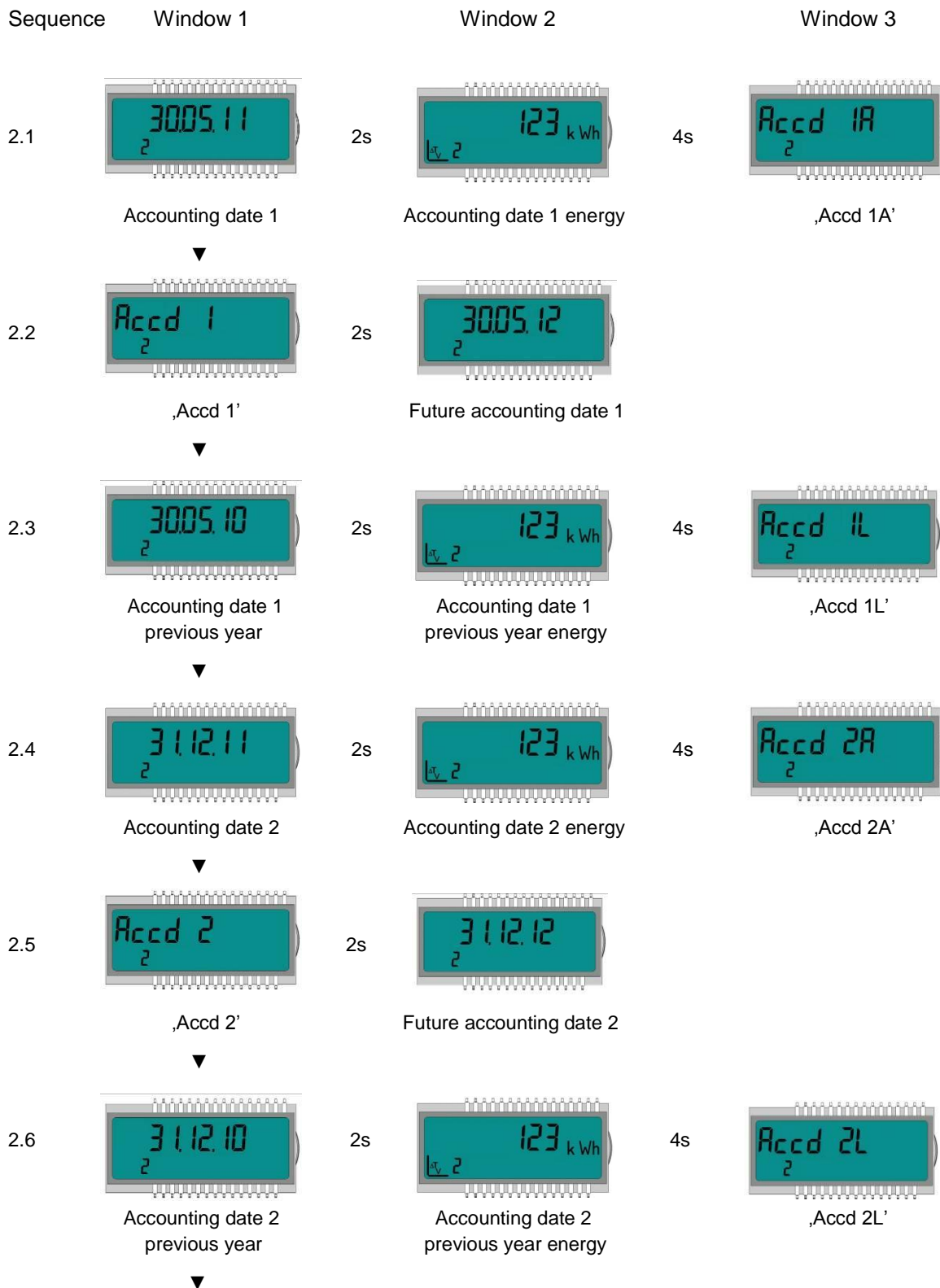

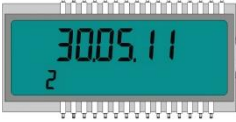
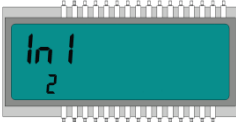

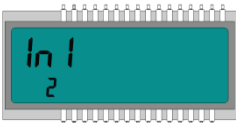

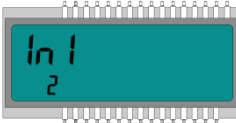
Sequence Window 1

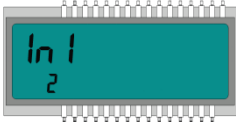

Sequence 1.1

Accounting date loop (2)



Sequence	Window 1	Window 2	Window 3
2.7	 Accounting date 1	2s  Pulse input 1	4s  Pulse input volume 1
	▼		
2.8	 Accounting date 1 previous year	2s  Pulse input 1	4s  Pulse input volume 1
	▼		
2.9	 Accounting date 2	2s  Pulse input 1	4s  Pulse input volume 1
	▼		
2.10	 Accounting date 2 previous year	2s  Pulse input 1	4s  Pulse input volume 1
	▼		
2.11	 Accounting date 1	2s  Pulse input 2	4s  Pulse input volume 2
	▼		
2.12	 Accounting date 1 previous year	2s  Pulse input 2	4s  Pulse input volume 2
	▼		

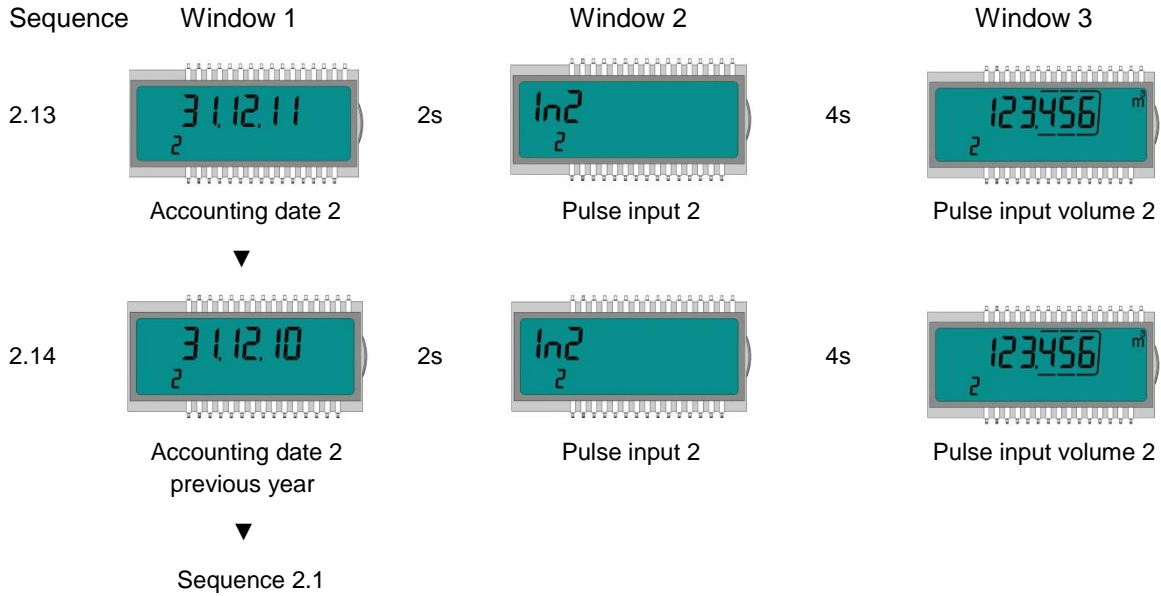

Info loop (3)

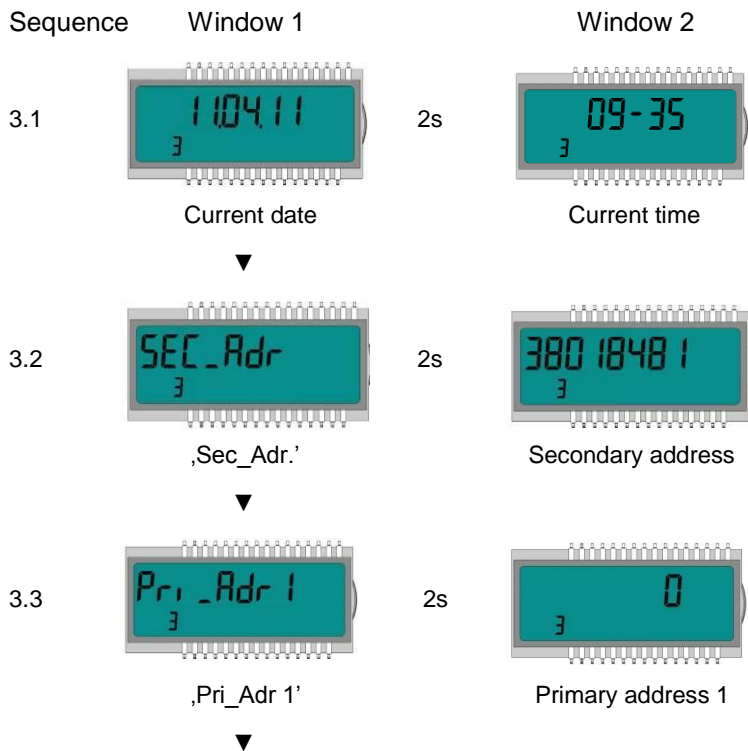

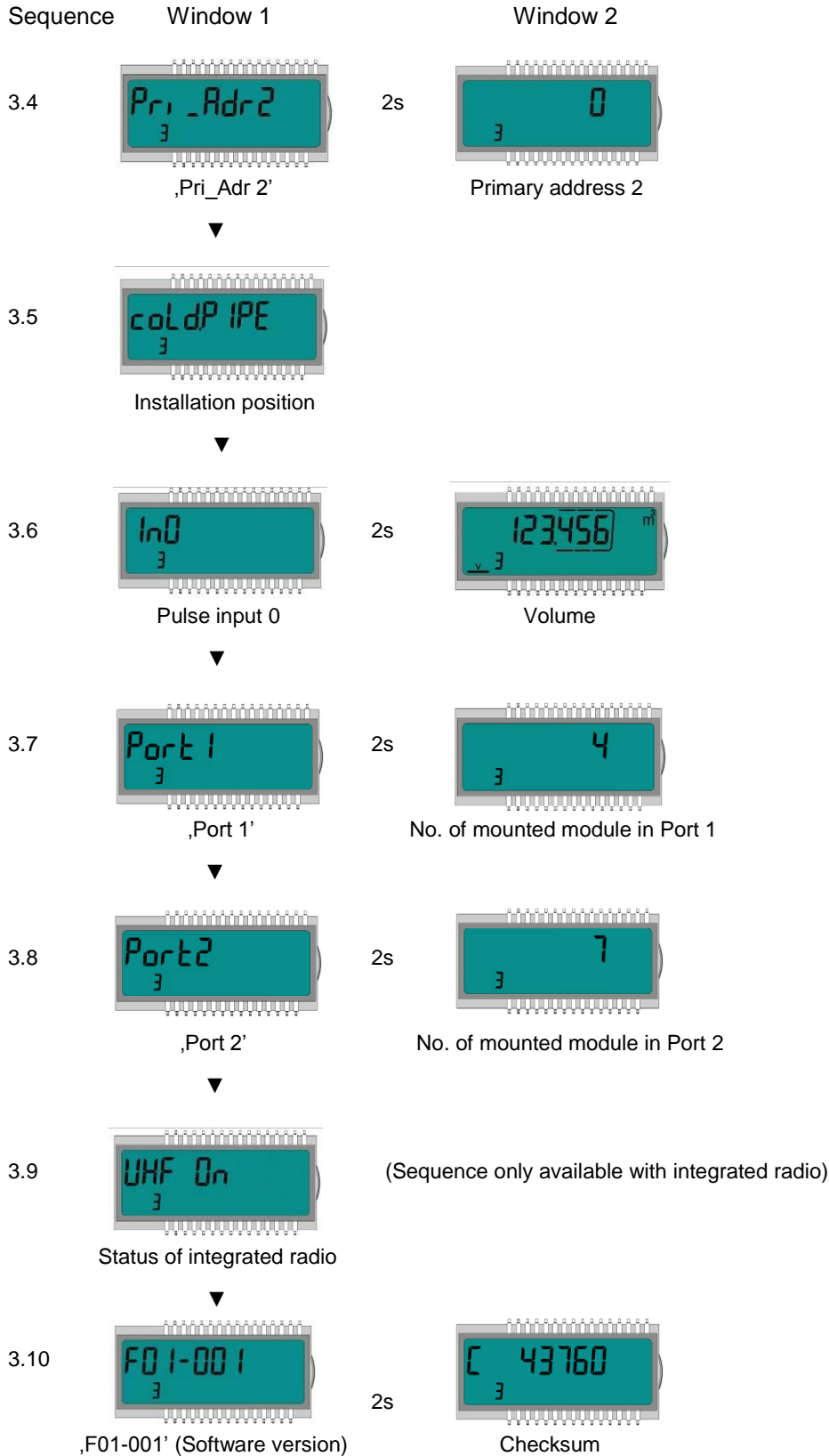

Sequence Window 1

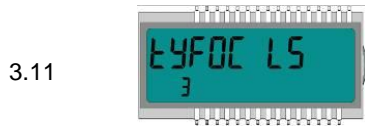

3.11

(Sequence only in a calculator with medium Tyfocor LS)

Medium Tyfocor LS



Sequence 3.1

Impulse loop (4)

Sequence Window 1

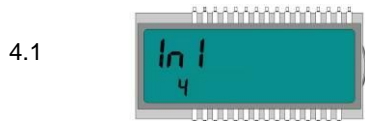

4.1

Pulse input 1



decimal place of
accumulate

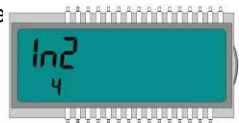

Pulse input 2



4.3



Pulse output 1



4.4

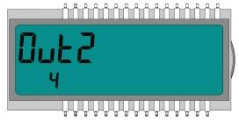

Pulse output 2



4.4

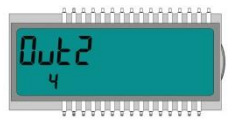

Pulse output 2



Window 2

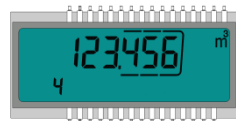

2s

Accumulated value

pulse input 1

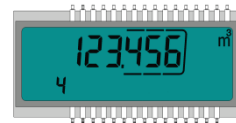

Accumulated value

pulse input 2



Value of pulse output 1

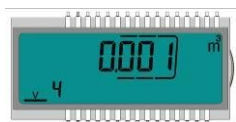

Value of pulse output 2

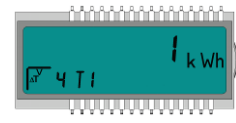

Value of pulse output 2

Window 3



4s

Pulse value 1 [L/P]

(depends on the
the

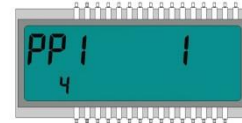

Pulse value 2 [L/P]

(depends on the decimal place
of the accumulated value)

(Sequence only in a calculator for
heating – or cooling)

(Sequence only in a calculator for
heating with cooling tariff)

Sequence 4.1

Tariff loop (5) (Only in a calculator for heating with cooling tariff)

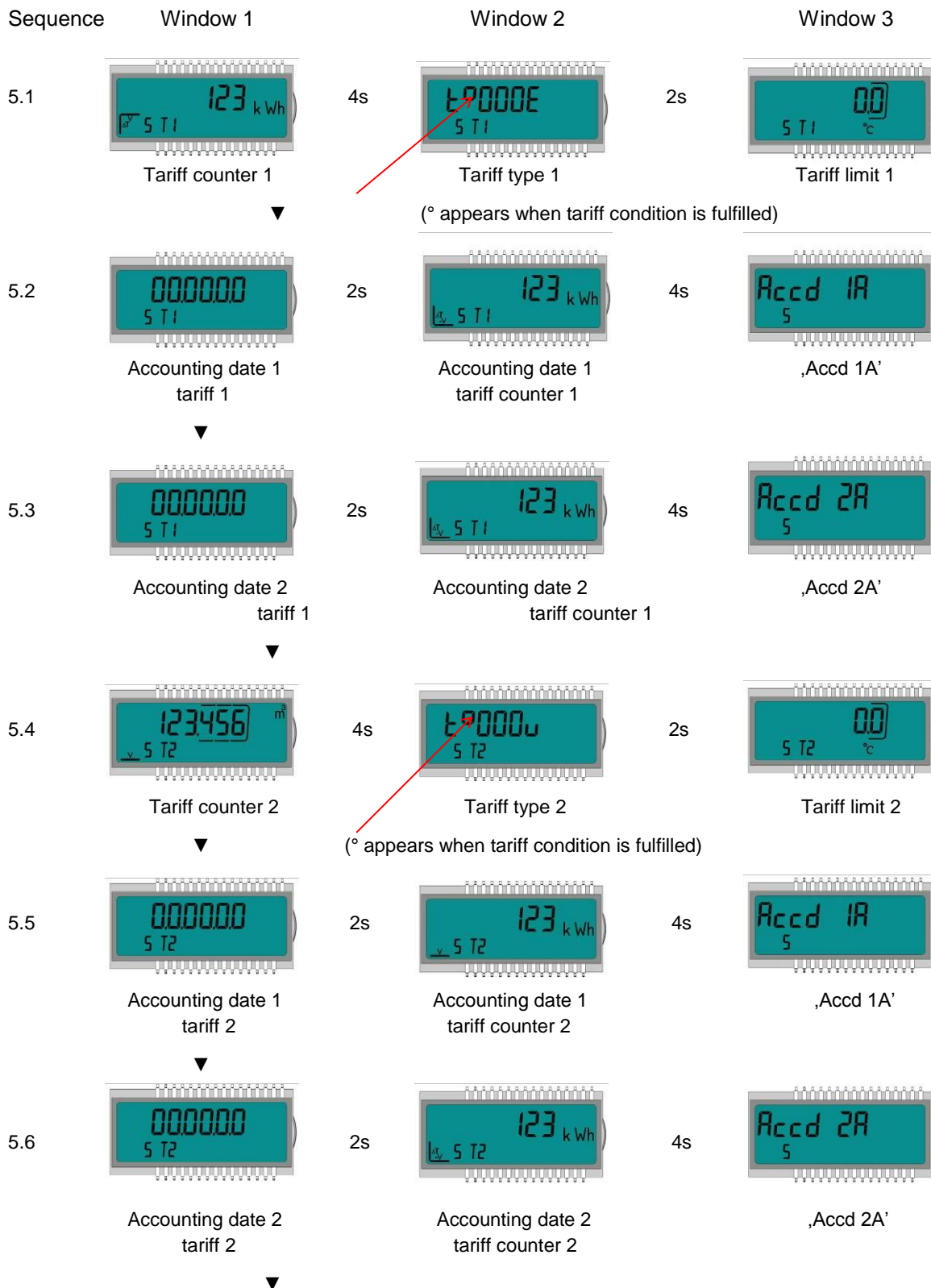

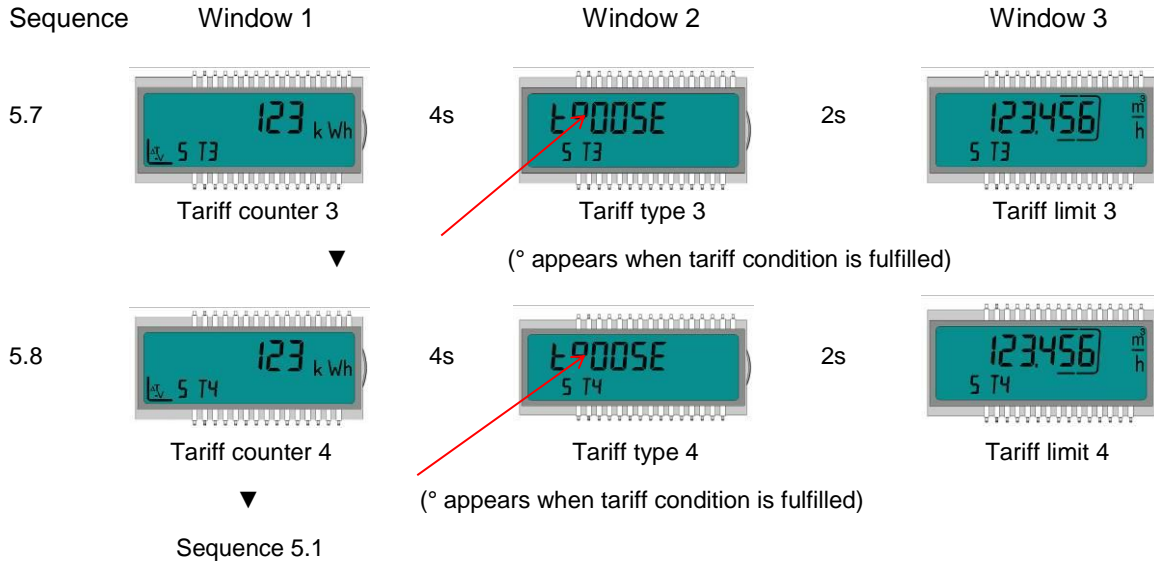

Monthly value loop (6) (Calculator for heating – or cooling)

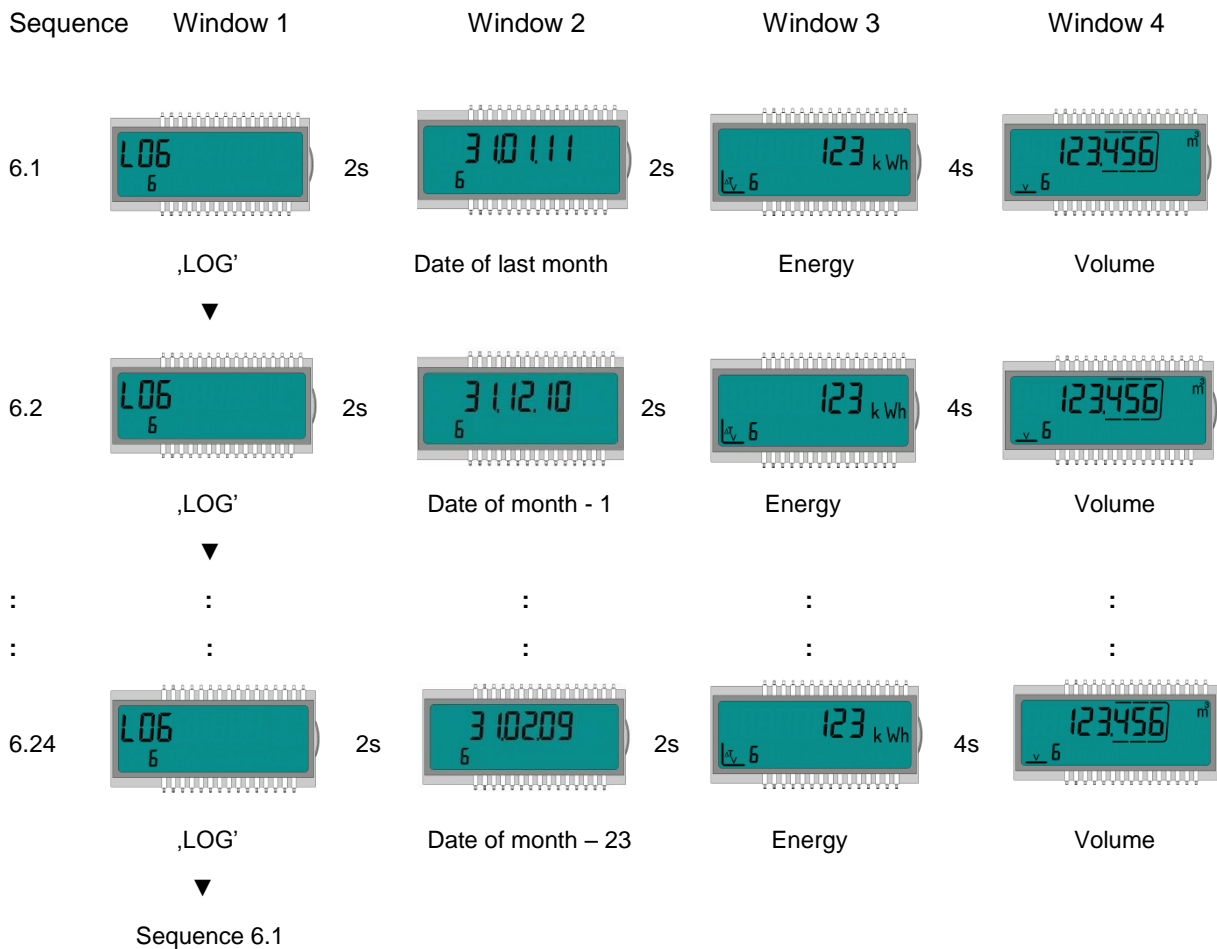

Monthly value loop (6) (Calculator for heating with cooling tariff)

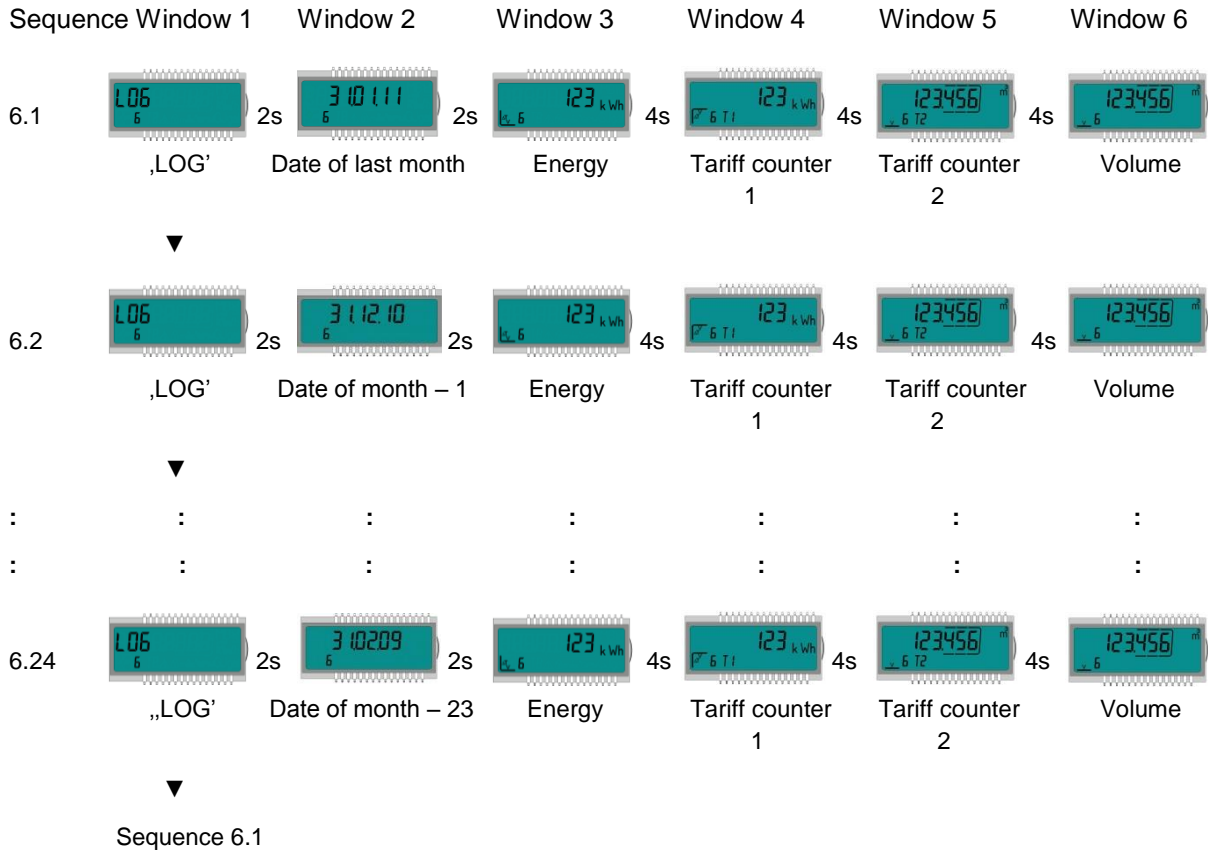

9 Maintenance and repair



NOTE

Information concerning repair and maintenance can be obtained from the Repair Concept.

10 Testing



Note

Information concerning testing can be obtained from the relevant Inspection and Test Instruction

Test information can also be found in the EC type examination certificate of the calculator under 5.1 (Test documentation) and in EN 1434-5. The number of the type examination certificate is printed on the calculator.

11 Removal



NOTE

The calculator contains a lithium battery. This must not be opened by force, come into contact with water, be short-circuited or exposed to temperatures above 85 °C. Used batteries and electronic equipment or components no longer required are to be handled as special waste.

- ⇒ Dismantle the calculator.
- ⇒ Dispose of the individual parts of the calculator at a suitable waste collection point.

12 Error analysis

The calculator continuously monitors its own operation and displays various error messages. The error code is displayed in the main loop if an error occurs. The permanent display shown corresponds to the “normal” display (e.g. a temperature sensor error is not shown in the flow rate display). In the basic display mode, the display changes between error codes and the basic display (exception: error display “C - 1” is shown permanently). All the other windows can still be selected by pressing the button.

The error display disappears automatically as soon as the cause of the error has been cleared. All errors present longer than 6 minutes are saved in the error log.

The following table shows the error codes indicated in the display with their respective meaning:

Error display	Meaning
C – 1	Basic parameter error in flash or RAM
E – 1	Temperature measurement error - Temperature range exceeded [-9.9 °C ... 190 °C] - Sensor short-circuit - Sensor break
E - 3**	Temperature sensors reversed in hot and cold lines
E – 5	Reading too frequently - M-Bus communication not possible for short time
E – 8	No primary voltage (only if mains unit used) - Powered by back-up battery
E – 9	Warning: battery nearly exhausted
E - A*	Leakage: pipe break detected
E - b*	Leakage: leakage detected calculator
E - C*	Leakage: leakage pulse input 1
E - d*	Leakage: leakage pulse input 2

* optional

** application-dependent

13 Declaration of conformity

DIEHL
Metering

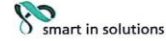

EG-Konformitätserklärung

EC Declaration of Conformity

Diehl Metering GmbH
Industriestr. 13
91522 Ansbach
GERMANY

DMDE-CE 145/2

Wir erklären hiermit, dass das Produkt / We hereby declare that the product

Rechenwerk / calculator
Type 548

Handelsname / trade name
SCYLAR INT 8, classic S3

EG-Baumusterprüfbescheinigung Nr.
EC Type-examination Certificate number
DE-10-MI004-PTB004

Nummer Benannte Stelle Modul D
Notified Body number module D
0102

(Typ entsprechend des Angebotes, der Auftragsbestätigung, der Gerätekenzeichnung;
Details in Montage- und/oder Bedienungsanleitung) konform ist mit folgenden Richtlinien des
Europäischen Parlaments und des Rates, soweit diese auf das Produkt Anwendung finden:
(Type according to the supply, the order confirmation, the equipment identification, Details
in assembly and/or instruction manual) are concurring with the following guidelines of the
European Parliament and the Council as far as these apply to the product:

EMV-Richtlinie (2004/108/EG)
LVD-Richtlinie (2006/95/EG)
MID-Richtlinie (2004/22/EG)
R&TTE-Richtlinie (1999/5/EG)

EMC Directive (2004/108/EC)
LVD Directive (2006/95/EC)
MID Directive (2004/22/EC)
RTTE Directive (1999/5/EC)

Das Produkt entspricht ferner den folgenden, angewendeten harmonisierten Normen bzw.
normativen Dokumenten, Regeln und Technischen Richtlinien (Stand wie angegeben).
Furthermore the product complies with the following used harmonised standards and
normative documents, rules and technical guidelines (level as indicated).

EN 55022:2010
EN 60529:2000
EN 61010-1:2010
EN 1434:2007
EN 301 489-1 v1.9.2
EN 60950-1:2006 + A11:2009 + A1:2010 + A12:2011 + AC:2011

EN 301 489-3 v1.4.1
EN 300 220-2 v2.4.1
OIML R75:2006
WELMEC 7.2:2009

Ansbach, 01.10.2014
Diehl Metering GmbH



ppa. R. Zahn
(Leiter Betrieb)
(Head of Operations)



ppa. Dr. K. Herrmann
(Leiter Entwicklung)
(Head of Research & Development)

Konformitätserklärung für Messgeräte, die nicht europäischen Vorschriften unterliegen

Diehl Metering GmbH
Industriestr. 13
91522 Ansbach
GERMANY

DMDE-NEV 413

Wir erklären hiermit, dass das Produkt

Bauart: Kältezähler-Rechenwerk mit austauschbaren
Temperaturfühlerpaaren Typ 548

Handelsname: SCYLAR INT 8

Innerstaatliche Bauartzulassung vom 06.05.2011
Zulassungszeichen: 22.75/11.02
Benannte Stelle Modul D: 0102

Typ entsprechend des Angebotes, der Auftragsbestätigung, der Gerätekenzeichnung,
(Details in Montage- und/oder Bedienungsanleitung) konform ist mit dem Mess- und
Eichgesetz (Bundesgesetzblatt Jahrgang 2013 Teil I Nr. 43 vom 31.07.2013) und den darauf
gestützten Rechtsverordnungen, soweit diese auf das Produkt Anwendung finden.

Das Produkt entspricht ferner den folgenden, angewendeten harmonisierten Normen bzw.
normativen Dokumenten, Regeln und Technischen Richtlinien (Stand wie angegeben):

Allgemeine Vorschriften der Eichordnung (EO-AV:1988/2007) mit Anlage 22
Technische Richtlinie K 16, Zulassungszeichen (2006)
Technische Richtlinie der PTB K7.2 (2006)
Anforderungen der PTB A50.7, Ausgabe April 2002
Anforderungen der PTB A50.1, Ausgabe Dezember 1989
CEN EN 1434:2007 OIML R 75 (2002/2006)
WELMEC-Leitfaden 7.2 (2009) DIN EN 60751:2009
EN 13757-2:2005 EN 13757-3:2005
DIN EN 61140:2003 DIN 12900-1:1998
DIN EN 60529:2000

Ansbach, 01.01.2015
Diehl Metering GmbH



ppa. R. Zahn
(Leiter Betrieb)



ppa. Dr. K. Herrmann
(Leiter Entwicklung)

Seite 1 von 1