



Fabryka Wodomierzy
PoWoGaz SA

KATALOG CZĘŚCI ZAMIENNYCH
WODOMIERZY TYPU **MW130-NC**
DO CIEPŁOMIERZY

SPARE PART CATALOGUE
OF THE **MW130-NC**- TYPE WATER METERS
FOR HEAT METERS

ERSATZTEILEKATALOG
MW130-NC- WASSERZÄHLER
FÜR WÄRMEZÄHLER

Nr 380

2001

Produkcja wodomierzy typu MW130-NC
Manufacturing of the MW130-NC type water meters
Produktion der Wasserzähler Bauart MW130-NC

| | |
|------------------------------------------|---------------------------------------------------------------------|
| Wodomierz Water-meter Wasserzähler | Produkcja od roku Production from the Year Production ab Jahr |
| MW130-50;65;80;100;125;150;200;250-NC | 1991 |

Warunki dostawy:

Zamówienia w 2-u egzemplarzach winny zawierać:

1. Nazwę i numer części
2. Ilość sztuk
3. Średnicę i typ wodomierza

Delivery conditions :

When ordering please specify:

1. Quantity of parts
2. Designation and part - No
3. Size and type of watermeter

Lieferungs Bedingungen:

Bei der Bestellung bitten wir anzugeben:

1. Stückzahl der Ersatzteile
2. Benennung und Teil - Nr
3. Zähler - Nenngrosse in mm

Dostawca:

Liferant:

Supplier:

FABRYKA WODOMIERZY
POWOGAZ S.A.
ul. Janickiego 23/25
60-542 Poznań



Fax: 061 8470192

061 8472548 Dz. Handlowy



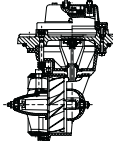
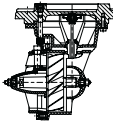
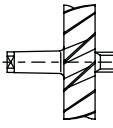
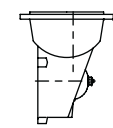
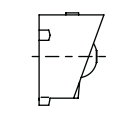
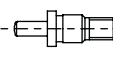

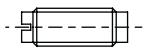
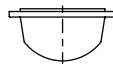
Tel. 061 8474401

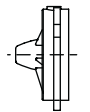
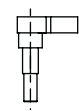
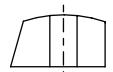

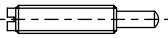
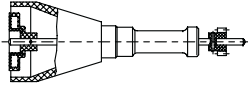
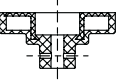
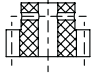
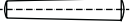

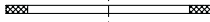
061 8470194 Dz. Handlowy

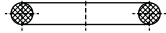

| Lp. | Nazwa części lub zespołu Designation of the part Teil Benennung | Numer katalogowy Catalogue - numer Katalog - Nr | | | | | | | | Szkiec Sketch Skizze |
|-----|---------------------------------------------------------------------------------|-------------------------------------------------------|--------------|--------------|--------------|--------------|--------------|--------------|--------------|---------------------------------------------------------------------------------------|
| | | MW130-50-NC | MW130-65-NC | MW130-80-NC | MW130-100-NC | MW130-125-NC | MW130-150-NC | MW130-200-NC | MW130-250-NC | |
| 1 | Wstawka pomiarowa Measuring unit Messeinsatz | 12080 | 12081 | 12082 | 12083 | 12084 | 12085 | 12086 | 12087 |  |
| 2 | Organ pomiarowy Measuring organ Messorgan | 12001 | 12000 | 12000 | 12000 | 12000 | 12100 | 12100 | 12100 |  |
| 3 | Wirnik kpl. Impeller - set Messflügel Kompl. | 12021 | 12021 | 12021 | 12021 | 12021 | 12121 | 12121 | 12121 |  |
| 4 | Wspornik z kołnierzem Bracket with flange Stützkonsole mit Flansch | 12030 | 12030 | 12030 | 12030 | 12030 | 12130 | 12130 | 12130 |  |
| 5 | Wspornik kpl. Bracket - set Stützkonsole Kompl. | 11531 | 11531 | 11531 | 11531 | 11531 | - | - | - |  |
| 6 | Oś wspornika kpl. Underslung bracket axle - set Hängelagerachse Kompl. | 12032 | 12032 | 12032 | 12032 | 12032 | 12132 | 12132 | 12132 |  |

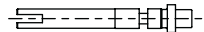

| Lp. | Nazwa części lub zespołu Designation of the part Teil Benennung | Numer katalogowy Catalogue - numer Katalog - Nr | | | | | | | | Szkic Sketch Skizze |
|-----|-------------------------------------------------------------------------------|-------------------------------------------------------|--------------|--------------|--------------|--------------|--------------|--------------|--------------|---------------------------------------------------------------------------------------|
| | | MW130-50-NC | MW130-65-NC | MW130-80-NC | MW130-100-NC | MW130-125-NC | MW130-150-NC | MW130-200-NC | MW130-250-NC | |
| 7 | Wkręt łożyska Bearing stop screw Lagerfeststelschraube | 11533 | 11533 | 11533 | 11533 | 11533 | 11533 | 11533 | 11533 |  |
| 8 | Kołnierz wspornika Bracket flange Stützerflansch | 12034 | 12034 | 12034 | 12034 | 12034 | - | - | - |  |
| 9 | Tulejka łożyskowa Bearing sleeve Lagerbuchse | 12035 | 12035 | 12035 | 12035 | 12035 | 12035 | 12035 | 12035 |  |
| 10 | Kierownica strumienia kpl. Stream guide ring - set Strahlrichter Kompl. | 12043 | 12041 | 12041 | 12041 | 12041 | 12141 | 12141 | 12141 |  |
| 11 | Trzpień regulacji Regulating shaft Regelwelle | 11538 | 11538 | 11538 | 11538 | 11538 | 11638 | 11638 | 11638 |  |
| 12 | Łopatkę regulacji Control blade Regelungsschaufel | 12039 | 12039 | 12039 | 12039 | 12039 | 12139 | 12139 | 12139 |  |

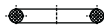
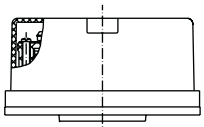

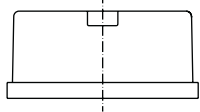
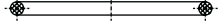
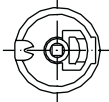
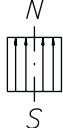
| Lp. | Nazwa części lub zespołu Designation of the part Teil Benennung | Numer katalogowy Catalogue - numer Katalog - Nr | | | | | | | | Szkic Sketch Skizze |
|-----|-------------------------------------------------------------------------------------------|-------------------------------------------------------|--------------|--------------|--------------|--------------|--------------|--------------|--------------|---------------------------------------------------------------------------------------|
| | | MW130-50-NC | MW130-65-NC | MW130-80-NC | MW130-100-NC | MW130-125-NC | MW130-150-NC | MW130-200-NC | MW130-250-NC | |
| 13 | Oś kierownicy strumienia kpl. Jet regulator axle - set Strahlrichterachse Kompl. | 12042 | 12042 | 12042 | 12042 | 12042 | 12142 | 12142 | 12142 |  |
| 14 | Ośłona sprzęgła z osią Worm-wheel cover with an axle Schneckenrad-verkleidung | 12053 | 12053 | 12053 | 12053 | 12053 | 12155 | 12155 | 12155 |  |
| 15 | Magnes dolny Lower coupling Untere Kupplung | 11555 | 11555 | 11555 | 11555 | 11555 | 11555 | 11555 | 11555 |  |
| 16 | Ślimacznica Worm-wheel Schneckenrad | 12051 | 12051 | 12051 | 12051 | 12051 | 12153 | 12153 | 12153 |  |
| 17 | Kołek stożkowy 1x8 Pin 1x8 Stift 1x8 | 10535 | 10535 | 10535 | 10535 | 10535 | 10535 | 10535 | 10535 |  |

| Lp. | Nazwa części lub zespołu Designation of the part Teil Benennung | Numer katalogowy Catalogue - numer Katalog - Nr | | | | | | | | Szkiec Sketch Skizze |
|-----|--------------------------------------------------------------------------------|-------------------------------------------------------|--------------|--------------|--------------|--------------|--------------|--------------|--------------|---------------------------------------------------------------------------------------|
| | | MW130-50-NC | MW130-65-NC | MW130-80-NC | MW130-100-NC | MW130-125-NC | MW130-150-NC | MW130-200-NC | MW130-250-NC | |
| 18 | Podkładka uszczelniająca Packing washer Dichtungsscheibe | 12054 | 12054 | 12054 | 12054 | 12054 | - | - | - |  |
| 19 | Tulejka łożyskowa Bearing sleeve Lagerbuchse | 12056 | 12056 | 12056 | 12056 | 12056 | 12056 | 12056 | 12056 |  |
| 20 | Kamień łożyskowy 3,5x2 Hole jewel 3,5x2 Lagerstein 3,5x2 | 11557 | 11557 | 11557 | 11557 | 11557 | 11557 | 11557 | 11557 |  |
| 21 | Ośłona sprzęgła kpl. Couplung cover - set Kupplungsverkleidung Kompl. | - | - | - | - | - | 12158 | 12158 | 12158 |  |
| 22 | Pierścień uszczelniający 40x3 Packing ring 40x3 Dichtungsring 40x3 | - | - | - | - | - | 11659 | 11659 | 11659 |  |

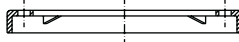
| Lp. | Nazwa części lub zespołu Designation of the part Teil Benennung | Numer katalogowy Catalogue - numer Katalog - Nr | | | | | | | | Szkiec Sketch Skizze |
|-----|--------------------------------------------------------------------------|-------------------------------------------------------|--------------|--------------|--------------|--------------|--------------|--------------|--------------|---------------------------------------------------------------------------------------|
| | | MW130-50-NC | MW130-65-NC | MW130-80-NC | MW130-100-NC | MW130-125-NC | MW130-150-NC | MW130-200-NC | MW130-250-NC | |
| 23 | Walek regulacji Control shaft Regelungswelle | 11502 | 11502 | 11502 | 11502 | 11502 | 11602 | 11602 | 11602 |  |
| 24 | Ramię regulacji Control bracket Regelungarm | 11503 | 11503 | 11503 | 11503 | 11503 | 11603 | 11603 | 11603 |  |
| 25 | Nakrętka regulacji Regulating nut Regelmutter | 11504 | 11504 | 11504 | 11504 | 11504 | 11504 | 11504 | 11504 |  |
| 26 | Podkładka ślizgowa Sliding washer Gleit Scheibe | 11505 | 11505 | 11505 | 11505 | 11505 | 11505 | 11505 | 11505 |  |
| 27 | Pierścień uszczelniający 3x2 Packing ring 3x2 Dichtungsring 3x2 | 11506 | 11506 | 11506 | 11506 | 11506 | 11506 | 11506 | 11506 |  |
| 28 | Mechanizm zliczający Counting gear Zählwerk | 13010 | 13010 | 13011 | 13012 | 13018 | 13013 | 13014 | 13015 |  |

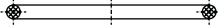
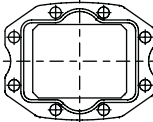
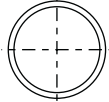
| Lp. | Nazwa części lub zespołu Designation of the part Teil Benennung | Numer katalogowy Catalogue - numer Katalog - Nr | | | | | | | | Szkiec Sketch Skizze |
|-----|-----------------------------------------------------------------------------|-------------------------------------------------------|--------------|--------------|--------------|--------------|--------------|--------------|--------------|---------------------------------------------------------------------------------------|
| | | MW130-50-NC | MW130-65-NC | MW130-80-NC | MW130-100-NC | MW130-125-NC | MW130-150-NC | MW130-200-NC | MW130-250-NC | |
| 29 | Ośłona liczydła Counter casing Zählwerks-Abdeckung | 13002 | 13002 | 13002 | 13002 | 13002 | 13002 | 13002 | 13002 |  |
| 30 | Pierścień uszczelniający 65x2 Packing ring 65x2 Dichtungsring 65x2 | 10024 | 10024 | 10024 | 10024 | 10024 | 10024 | 10024 | 10024 |  |
| 31 | Oprawa magnesu Magnet mounting Magnetfassung | 13003 | 13003 | 13003 | 13003 | 13003 | 13003 | 13003 | 13003 |  |
| 32 | Magnes Magnet Magnet | 13004 | 13004 | 13004 | 13004 | 13004 | 13004 | 13004 | 13004 |  |
| 33 | Pierścień dociskowy Holding ring Druckring | 12060 | 12060 | 12060 | 12060 | 12060 | 12060 | 12060 | 12060 |  |

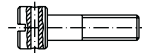
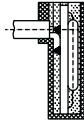
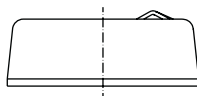
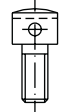
| Lp. | Nazwa części lub zespołu Designation of the part Teil Benennung | Numer katalogowy Catalogue - numer Katalog - Nr | | | | | | | | Szkiec Sketch Skizze |
|-----|--------------------------------------------------------------------------------|-------------------------------------------------------|--------------|--------------|--------------|--------------|--------------|--------------|--------------|---------------------------------------------------------------------------------------|
| | | MW130-50-NC | MW130-65-NC | MW130-80-NC | MW130-100-NC | MW130-125-NC | MW130-150-NC | MW130-200-NC | MW130-250-NC | |
| 34 | Pierścień osłaniający Guard ring Schützring | 13016 | 13016 | 13016 | 13016 | 13016 | 13016 | 13016 | 13016 |  |
| 35 | Pierścień uszczelniający Packing ring Dichtungsring | 12062 | 12062 | 12062 | - | - | - | - | - |  |
| 36 | Pierścień uszczelniający 115x5 Packing ring 115x5 Dichtungsring 115x5 | 11563 | 11563 | 11563 | 11563 | 11563 | - | - | - |  |
| 37 | Uszczelka pokrywy Cover gasket Deckelabdichtung | - | - | - | - | - | 12164 | 12164 | 12164 |  |
| 38 | Pierścień ślizgowy Sliding ring Gleitring | - | - | - | - | - | 11665 | 11665 | 11665 |  |

| Lp. | Nazwa części lub zespołu Designation of the part Teil Benennung | Numer katalogowy Catalogue - numer Katalog - Nr | | | | | | | | Szkiec Sketch Skizze |
|-----|-----------------------------------------------------------------------|-------------------------------------------------------|--------------|--------------|--------------|--------------|--------------|--------------|--------------|---------------------------------------------------------------------------------------|
| | | MW130-50-NC | MW130-65-NC | MW130-80-NC | MW130-100-NC | MW130-125-NC | MW130-150-NC | MW130-200-NC | MW130-250-NC | |
| 39 | Wkręt specjalny Special screw Spezialschraube | 11566 | 11566 | 11566 | 11566 | 11566 | 11566 | 11566 | 11566 |  |
| 40 | Zespół nadajnika Transmitter unit Gebersatz | 13006 | 13006 | 13006 | 13006 | 13006 | 13006 | 13006 | 13006 |  |
| 41 | Ekran magnetyczny Magnetic shield Magnetschutz | 13030 | 13030 | 13030 | 13030 | 13030 | 13030 | 13030 | 13030 |  |
| 42 | Wkręt specjalny Special screw Spezialschraube | 13008 | 13008 | 13008 | 13008 | 13008 | 13008 | 13008 | 13008 |  |
| 43 | Dławik Chocking coil Drosselspule | 13039 | 13039 | 13039 | 13039 | 13039 | 13039 | 13039 | 13039 |  |

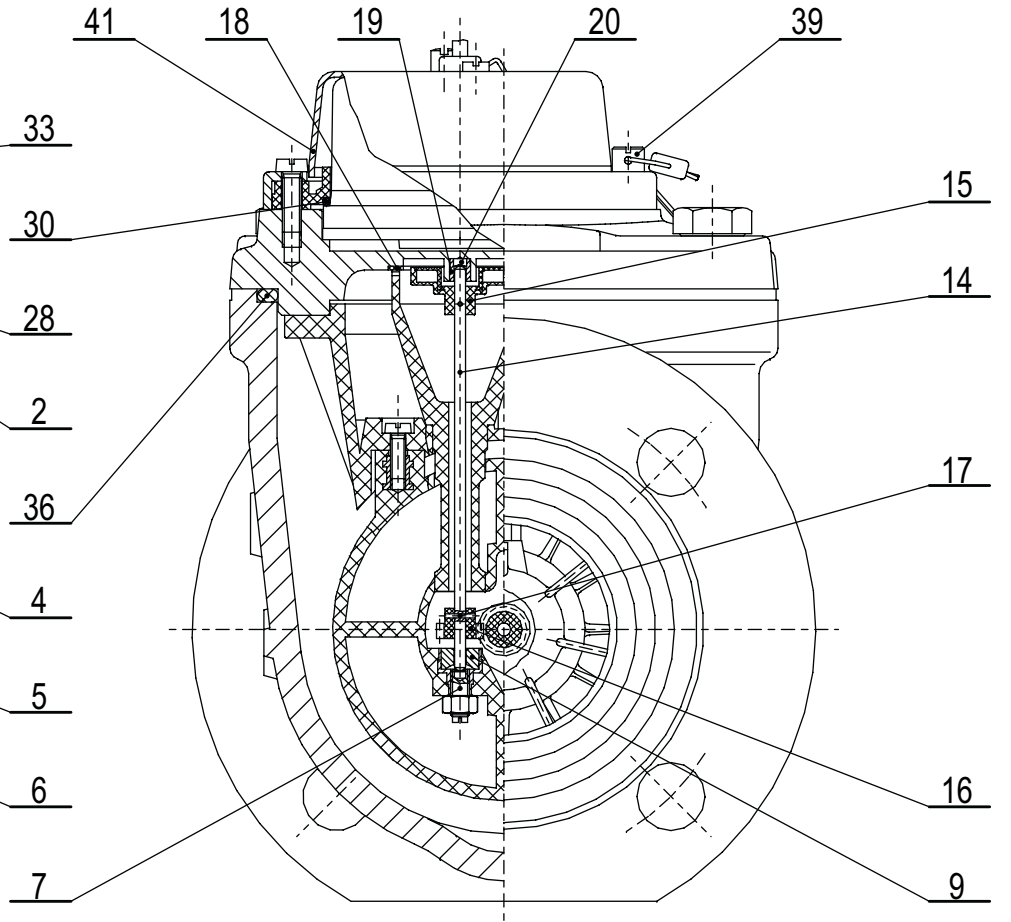
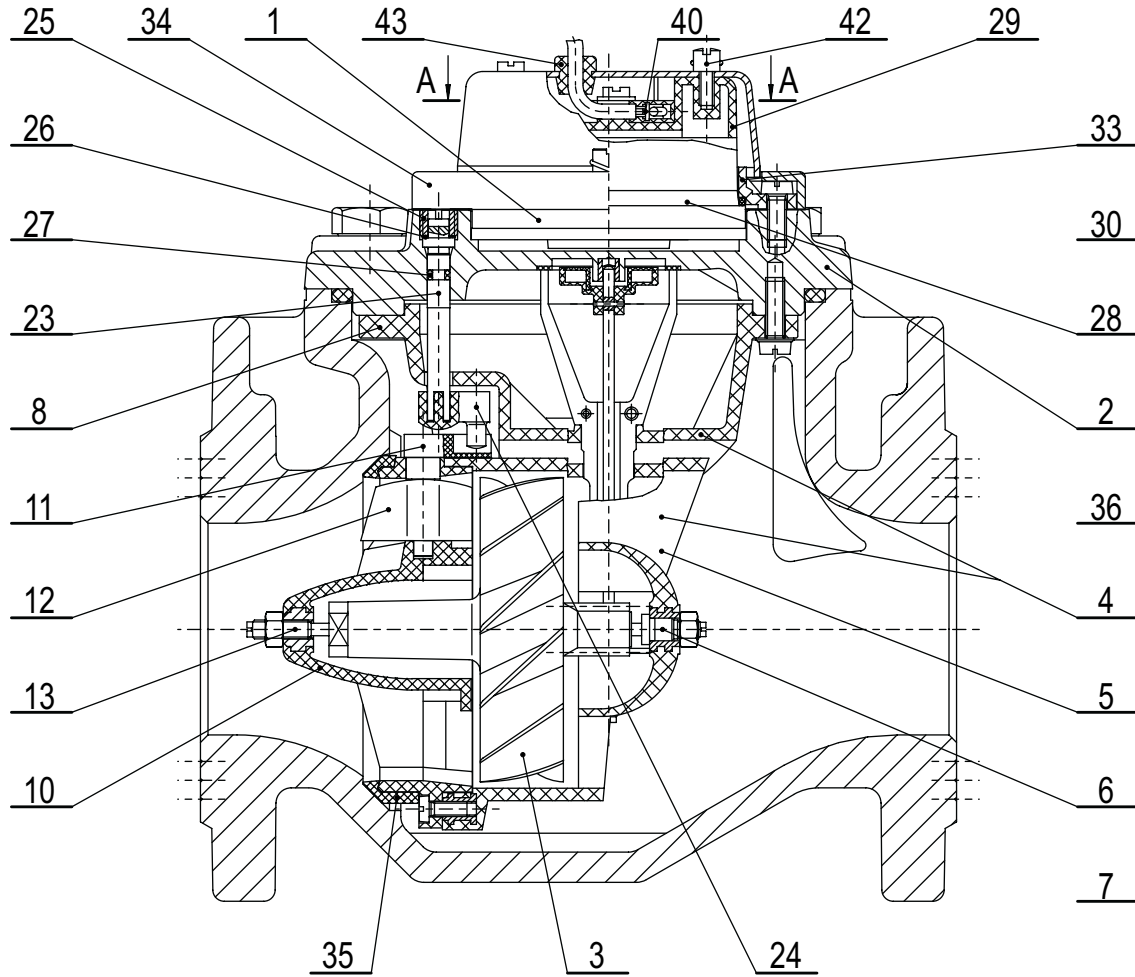

MW130-150 ÷ 250 - NC

